

DIGITAL VIDEO • RF COAX BOARD TO BOARD

DISPLAYPORT AUDIO/VIDEO CONNECTORS (CONT.)

DISPLAYPORT CONNECTORS - PC BOARD MOUNT

Mfg. Part No.	Gender	Termination	Stock No.	Price Each	
				1-99	100-249
62U020S-301N-B1B	Receptacle	SMT	46P5271	1.52	1.18
62L020S-303N-B1P-B1P	Receptacle	Thru Hole	46P5272	1.52	1.18

DISPLAYPORT CONNECTORS - CABLE MOUNT

62S020S-30ANE-B	Receptacle	Solder	46P5273	1.59	1.23
62S020M-301N-E1-B0PB	Plug	Solder	46P5275	1.50	1.20
62S020P-301N-E1-B2P	Plug	Solder w/Hood	46P5274	1.71	1.37

(140345)

MINI HDMI CONNECTORS

Just Added



Specifications

- Current rating: 0.5 A
- Insulation resistance: 100 Mohm min untested; 10Mohm mated
- Dielectric withstanding voltage: between adjacent terminals: 500 VAC untested; 300VAC mated
- Operating temperature: -25°C to 85°C

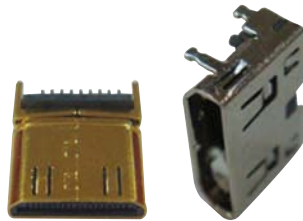

MINI HDMI PLUGS - SOLDER TERMINATION

Mfg. Part No.	Description	Stock No.	Price Each
60S019P-301N-B	Type C with extended PCB	06R5629	1.06
60S019P-301N-B1	Type C	06R5630	0.99
60S019P-301N-B2	Type C Male to Type A Female PCB	06R5631	1.13

MINI HDMI RECEPTACLES - RIGHT ANGLE PCB MOUNT

60U019S-340N-B1	Notched Through Hole Shell Termination	06R5632	1.06
60U019S-341N-B1	Straight Through Hole Shell Termination	06R5633	1.06
60U019S-342N-B1	SMT Shell Termination	06R5634	1.06

(147264)

HDMI CONNECTORS AND CABLE ASSEMBLIES



Specifications

- Current Rating: 0.5 A
- Insulation Resistance: 100 MΩ/m
- Voltage Rating: 40 VAC
- Operating Temperature: -25°C to 85°C



PCB MOUNT CONNECTORS

Mfg. Part No.	Description	Stock No.	Price Each
51U019S-325N-AR-B	SMT Right Angle	74M7339	1.24
51U019S-333N-B	SMT Right Angle with flange	74M7340	1.20
51U019S-336N-B	SMT Right Angle with flange	74M7341	1.24
51L019S-36EN-B	Through Hole R/A with flange	74M7338	1.28
51V019S-33WN-B	SMT Vertical with flange	74M7342	1.24

ADAPTERS

1901117	HDMI Male to DVI Female	74M6205	5.26
1901116	HDMI Female to DVI Male	74M6204	5.26
1901118	HDMI Female to DVI Female	74M6206	5.52
1901119	HDMI Female to HDMI Female	74M6207	5.52
1901121	HDMI Female to HDMI Female R/A	74M6208	5.52
1901122-31C-A	Extender	74M6209	54.43

HDMI CABLE ASSEMBLIES

Mfg. Part No.	Length (m)	Stock No.	Price Each
18-94192666	2	74M6165	7.97
18-94192667	3	74M6166	9.77
18-94192670	10	74M6167	20.92
18-94192672	15	74M6168	57.01

(116637)

VHDCI CONNECTORS

Specifications

- Current Rating: 0.3 A
- Insulation Resistance: 500 MΩ/m
- Voltage Rating: 30 VAC
- Operating Temperature: -25°C to 85°C



Mfg. Part No.	Description	Stock No.	Price Each
34D068P-32614-AH	VHDCI Plug	74M7093	7.18
34D068P-32600-AK	VHDCI Plug with Hood & Screws	74M7092	4.13

RIGHT ANGLE PCB MOUNT RECEPTACLES

34L068S-326H-BB-HT	VHDCI Receptacle	74M7096	6.11
34E068S-328H-AD	Stacked 2 x 68 with Screws	74M7094	11.31
34E068S-328W-BB	Stacked 2 x 68 without Screws	74M7095	10.99

(116638)

50-OHM OSMP CONNECTORS



- Gold-plated beryllium copper contacts
- Temp. range: -65°C to +165°C

STRAIGHT JACK

Mfg. Part No.	Fig.	RG/U	Coaxial Termination	Connector Mounting	Stock No.	Price Each
1056526-1	1	0.047" Semi-Rigid	Solder	Cable	96M0592	16.29
1056527-1	1	405, 0.085" Semi-Rigid	Solder	Cable	96M0593	16.29

RIGHT ANGLE JACK

1056554-1	2	405, 0.085" Semi-Rigid	Solder	Cable	96M0594	16.29
1056553-1	2	0.047" Semi-Rigid	Solder	Cable	10H7225	30.92

STRAIGHT PLUG

1253562-1	3	...	Solder	PC Board	96M0623	17.36
-----------	---	-----	--------	----------	---------	-------

RIGHT ANGLE PLUG

1061692-1	Solder	PC Board	96M0616	19.60
-----------	-----	-----	--------	----------	---------	-------

SHROUD (STAINLESS STEEL)

1056751-1	Solder	Panel	96M0598	30.56
-----------	-----	-----	--------	-------	---------	-------

HERMETIC SEAL SUB-ASSEMBLY (GLASS BEAD)

1056728-1	10H7228	14.88
-----------	-----	-----	-----	-----	---------	-------

STRAIGHT ADAPTER

Mfg. Part No.	Fig.	Convert From	Convert To	Stock No.	Price Each
1056700-1		OSMP Jack	OSMP Jack	96M0595	15.35

(114899)

50 OHM SMP CONNECTORS

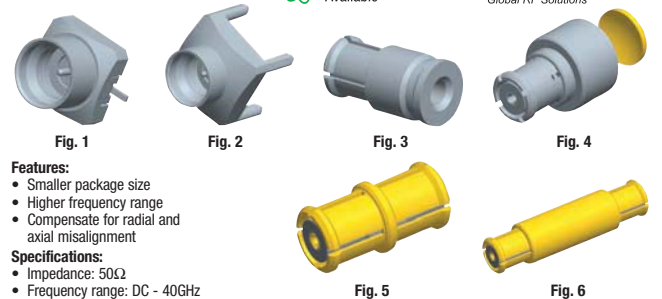

Features:

- Smaller package size
- Higher frequency range
- Compensate for radial and axial misalignment

Specifications:

- Impedance: 50Ω
- Frequency range: DC - 40GHz
- VSWR: <1.50 (0-20GHz)

Designed for use in aerospace, board-to-board interconnect, broadband, instrumentation, Mi/Aero, optical nodes and routers, phased array antennas, and telecommunications. Provide microwave performance through 40GHz and offer a push-on high performance interconnect system. Body plating: gold. Contact finish: gold. Insulator material: PTFE.

▶ CONTINUED ▶

RF COAX BOARD TO BOARD

50 OHM SMP CONNECTORS (CONT.)

STRAIGHT PC BOARD JACKS

Mfg. Part No.	Fig.	Termination	RG Cable Type	Stock No.	Price Each	
					1-9	10-24
● SMP-MSLD-PCS*	1	Surface Mount	...	80K6927	8.74	8.67
● SMP-MSLD-PCT	2	Through Hole	...	73K9435	11.24	10.28
● SMP-MSSB-PCS*	1	Surface Mount	...	80K6928	9.45	8.56
● SMP-MSSB-PCT	2	Through Hole	...	73K9438	11.92	10.83

STRAIGHT PLUGS

● SMP-FS-C06	3	Solder		80K6926	11.85	10.87
● SMP-FS-C07	3	Solder	405, 0.085" Semi-Rigid	73K9425	15.40	14.07

RIGHT-ANGLE PLUGS

● SMP-FR-C06	4	Solder		73K9424	16.32	14.84
● SMP-FR-C07	4	Solder	405, 0.085" Semi-Rigid	63K2481	11.12	10.85

*Insulator material: LCP.

IN-SERIES ADAPTERS

Mfg. Part No.	Fig.	Body Style	Length (mm)	Stock No.	Price Each	
					1-9	10-24
● SMP-FSBA-645	5	Straight Adapter, Jack-Jack	6.45	73K9431	14.49	13.24
● SMP-FSBA-990	6	Straight Adapter, Jack-Jack	9.9	73K9432	13.65	12.28
● SMP-FSBA-145	6	Straight Adapter, Jack-Jack	14.5	73K9427	10.85	10.02
● SMP-FSBA-224	6	Straight Adapter, Jack-Jack	22.4	73K9430	14.47	13.02

(87539)

50-OHM SMP CONNECTORS, ADAPTERS AND ASSEMBLY TOOLS



SMP blind-mate connectors provide a micro-miniature, slide-on/snap-on interconnect system that aids in the design of high density packaging as well as axial and radial misalignment issues. SMP series MIL-STD-348A interface design offers up to 40GHz frequency range and is compatible with all SMP and GPO® connectors. Operating temperature: -65°C to +165°C.

RIGHT ANGLE JACK (GOLD-PLATED BERYLLIUM COPPER CONTACTS)

Mfg. Part No.	Fig.	RG/U	Coaxial Termination	Connector Mounting	Stock No.	Price Each	
						1-9	10-24
● 127-0692-101	1	M17/151, .047" Semi-Rigid	Solder	Cable	78M7330	13.59	12.88
● 127-0693-101	1	405, 0.085" Semi-Rigid	Solder	Cable	78M7332	12.86	12.18

STRAIGHT JACK

● 127-0692-001	2	M17/151, .047" Semi-Rigid	Solder	Cable	78M7329	10.29	9.75
● 127-0693-001	2	405, 0.085" Semi-Rigid	Solder	Cable	78M7331	11.02	10.44

➤ CONTINUED ➤

50-OHM SMP CONNECTORS, ADAPTERS AND ASSEMBLY TOOLS (CONT.)

STRAIGHT PLUG (GOLD-PLATED BERYLLIUM COPPER CONTACTS)

Mfg. Part No.	Fig.	Interface	Coaxial Termination	Connector Mounting	Stock No.	Price Each	
						1-9	10-24
● 127-0701-201	3	Full Detent	Solder	PC Board	78M7333	8.85	8.39
● 127-1701-201	3	Limited Detent	Solder	PC Board	78M7341	8.85	8.39
● 127-2701-201	3	Smooth Bore	Solder	PC Board	78M7347	8.85	8.39
● 127-3701-201	3	Catcher's Mit	Solder	PC Board	78M7353	8.85	8.39
● 127-0701-801	4	Full Detent	Solder	PC Board	78M7336	9.63	9.12
● 127-1701-801	4	Limited Detent	Solder	PC Board	78M7344	9.63	9.12
● 127-2701-801	4	Smooth Bore	Solder	PC Board	78M7350	12.49	11.84

STRAIGHT ADAPTER (GOLD-PLATED BERYLLIUM COPPER CONTACTS)

Mfg. Part No.	Fig.	Interface	Convert From	Convert To	Stock No.	Price Each	
						1-9	10-24
● 127-0901-801	5	...	SMP Jack	SMP Jack	78M7338	7.81	7.40
● 127-0901-811	6	...	SMP Jack	SMP Jack	78M7339	11.97	11.34
● 127-0901-822	7	Full Detent	SMP Plug	SMP Plug Catcher's Mit	78M7340	14.16	13.42
● 127-1901-822	7	Limited Detent	SMP Plug	SMP Plug Catcher's Mit	78M7346	14.16	13.42
● 127-2901-822	7	Smooth Bore	SMP Plug	SMP Plug Catcher's Mit	78M7352	14.16	13.42

FIELD REPLACEABLE (GOLD-PLATED BERYLLIUM COPPER CONTACTS)

Mfg. Part No.	Fig.	Description	Stock No.	Price Each	
				1-9	10-24
● 127-0701-612	8	2-Hole Flange Mount Male, Full Detent	78M7335	13.01	12.33
● 127-1701-612	8	2-Hole Flange Mount Male, Limited Detent	78M7343	13.53	12.82
● 127-2701-612	8	2-Hole Flange Mount Male, Smooth Bore	78M7349	13.53	12.82

SHROUD W/OUT CONTACT (STAINLESS STEEL BODY)

● 127-0701-602	9	2-Hole Flange Mount Male, Full Detent	78M7334	3.91	3.70
● 127-1701-602	9	2-Hole Flange Mount Male, Limited Detent	78M7342	3.91	3.70
● 127-2701-602	9	2-Hole Flange Mount Male, Smooth Bore	78M7348	3.91	3.70
● 127-3701-602	10	2-Hole Flange Mount Male, Catcher's Mit	78M7354	5.88	5.57

HERMETIC SHROUD (GOLD-PLATED KOVAR ALLOY CONTACTS)

● 127-0711-601	11	Hermetic Seal Male, Full Detent	78M7337	17.69	16.77
● 127-1711-601	11	Hermetic Seal Male, Limited Detent	78M7345	17.69	16.77
● 127-2711-601	11	Hermetic Seal Male, Smooth Bore	78M7351	17.69	16.77

ASSEMBLY TOOLS

Mfg. Part No.	Fig.	Description	Stock No.	Price Each	
				1-4	
● 127-0000-900	12	Bullet Extraction Tool	78M7321	171.60	
● 127-0000-901	13	Cabled Connector Removal Tool	78M7322	18.04	
● 127-0000-902	14	Center Contact Holder	78M7323	9.84	
● 127-0000-903	15	Interface Locator Tool	78M7324	24.60	
● 127-0000-904	16	Right Angle Body Holder	78M7325	9.84	
● 127-0000-905	17	Shroud Centering Tool, Full Detent	78M7326	9.84	
● 127-0000-906	17	Shroud Centering Tool, Limited Detent	78M7327	9.84	
● 127-0000-907	17	Shroud Centering Tool, Smooth Bore	78M7328	9.84	

(108519)

50-OHM SMP CONNECTORS



Mfg. Part No.	Body Style	Description	RG/U	Stock No.	Price Each	
					1-24	
● 73415-3030	Right Angle Jack	Cable, Solder	0.086" Semi-Rigid	32M0818	6.18	
● 73415-3310	Straight Plug	Catcher Mit w/Ltd. Detent, PCB, Thru Hole	...	32M0820	4.95	
● 73415-3320	Straight Plug	Catcher Mit, Smooth Bore, PCB, Thru Hole	...	32M0821	3.09	
● 73415-5030	Right Angle Jack	Cable, Crimp	174, 188, 316	32M0826	11.43	
● 73415-5120	Right Angle Jack	Cable, Solder	0.047" Semi-Rigid	32M0827	9.65	
● 85305-0232	Straight Plug	Limited Detent, SMT	...	32M0828	4.47	

(90504)



eInvoices

Now you can view, print or email Newark invoices from our website under MY ACCOUNT eSuite. Log in or register today.

(148830)

50- AND 75-OHM ZDC SERIES BNC CONNECTORS



- DC - 4GHz frequency range
- Durability: 50 cycles minimum
- Gold-plated phosphor bronze contacts (jacks)
- Gold-plated brass contacts (plugs)
- Operating temperature range: -55°C to +85°C

The connector interfaces are compatible with the requirements of MIL-C-39012 and MIL STD348A, and are therefore interchangeable with products manufactured to these specifications. The crimp connectors utilize standard hexagonal crimp tools and die-sets.

RIGHT ANGLE BULKHEAD JACK

Mfg. Part No.	Impedance (Ohms)	RG/U	Connector Mounting	Coaxial Termination	Stock No.	Price Each	
						1-49	50-99
5-1634556-0	50	...	PC Board	Solder	78M7243	2.94	2.60

RIGHT ANGLE JACK

1-1634613-0	50	...	PC Board	Solder	89K7480	2.08	1.84
1-1337542-0	50	...	PC Board	Solder	78M7204	2.08	1.84
1-1634612-0	50	...	PC Board	Solder	78M7210	2.08	1.84
1-1337543-0	50	...	PC Board	Solder	63K9785	2.08	1.84
1-1337494-0	50	...	PC Board	Solder	78M7202	3.26	2.88
5-1634513-1	50	...	PC Board	Solder	60M9860	2.49	2.20
1-1634624-0	75	...	PC Board	Solder	78M7212	2.17	1.91
1-1478031-0	75	...	PC Board	Solder	78M7205	2.17	1.91
1-1634622-0	75	...	PC Board	Solder	78M7211	2.17	1.91
1-1478032-0	75	...	PC Board	Solder	78M7206	2.17	1.91
1-1634508-0	75	...	PC Board	Solder	78M7209	2.75	2.43

STRAIGHT BULKHEAD JACK

5-1634523-1	50	...	Cable	Crimp	87K0402	1.44	1.27
5-1634504-1	50	...	Cable	Crimp	78M7224	2.36	2.09
5-1634516-1	50	58	Cable	Crimp	78M7232	2.88	2.54
5-1634521-1	50	...	PC Board	Solder	78M7234	2.58	2.28
5-1634504-2	75	...	Cable	Crimp	78M7225	2.45	2.16
5-1634516-5	75	59	Cable	Crimp	78M7233	3.22	2.85

STRAIGHT JACK

5-1634511-3	50	58	Cable	Crimp	78M7229	2.28	1.96
5-1634511-2	50	58	Cable	Crimp	78M7228	1.87	1.65
1-1634505-0	50	...	PC Board	Solder	78M7208	2.17	1.91
1-1337541-0	50	...	PC Board	Solder	78M7203	2.17	1.91
5-1634503-1	50	...	PC Board	Solder	78M7222	1.54	1.36
5-1634506-1	50	...	PC Board	Solder	78M7226	1.52	1.34
5-1634514-1	75	59	Cable	Crimp	78M7231	2.35	2.03
5-1634514-0	75	59	Cable	Crimp	78M7230	1.95	1.72
1-1634629-0	75	...	PC Board	Solder	78M7213	2.17	1.91
1-1478033-0	75	...	PC Board	Solder	78M7207	2.17	1.91
5-1634503-3	75	...	PC Board	Solder	78M7223	1.54	1.36
5-1634506-2	75	...	PC Board	Solder	78M7227	1.83	1.57

STRAIGHT PLUG

5-1634500-2	50	58	Cable	Crimp	78M7218	1.34	1.18
5-1634500-3	50	58	Cable	Crimp	78M7219	1.48	1.27
5-1634500-1	50	174	Cable	Crimp	78M7217	1.98	1.75
5-1634500-0	50	174	Cable	Crimp	78M7216	1.80	1.59
5-1634502-2	75	59	Cable	Crimp	78M7220	1.65	1.42
5-1634502-3	75	59	Cable	Crimp	78M7221	1.33	1.17

RIGHT ANGLE ADAPTER

Mfg. Part No.	Impedance (Ohms)	Convert From	Convert To	Stock No.	Price Each	
					1-49	50-99
5-1634526-1	50	BNC Plug	BNC Jack	78M7235	3.35	2.96

STRAIGHT BULKHEAD ADAPTER

5-1634530-1	50	BNC Jack	BNC Jack	78M7236	2.49	2.20
-------------	----	----------	----------	---------	------	------

STRAIGHT ADAPTER

5-1634534-1	50	BNC Jack	BNC Jack	78M7238	1.87	1.65
-------------	----	----------	----------	---------	------	------

TEE ADAPTER

5-1634535-1	50	BNC Jack	BNC Jack Jack	78M7239	2.79	2.47
5-1634532-1	50	BNC Plug	BNC Jack Jack	78M7237	2.21	1.95

➔ CONTINUED ➔

50- AND 75-OHM ZDC SERIES BNC CONNECTORS (CONT.)

ACCESSORIES

Mfg. Part No.	Description	Stock No.	Price Each
			1-49
1-1634816-0	Hexagonal Jam Nut	78M7214	0.24
1-1634817-0	Lockwasher	78M7215	0.18

(106862)

AMP 50-OHM BNC PLUGS



1-221265

5225974-5

414265

- Commercial Grade
- Gold/Nickel Plating

SOLDER CLAMP FIELD SERVICEABLE PLUGS— MEETS MIL-C-39012, CATEGORY A SPECS

Mfg. Part No.	RG/U	Stock No.	Price Each	
			1-24	25-49
1-221265-1	124, 140, 210, 62, 62A, 62B, 59, 59A, 59B, Belden 9291, 9209, 9268, 88241, Hi-Temp. 62A, Times PL-62, Berk-Tek BTDC -59, -62, 302, 71, 71A, 71B	36K3739	28.25	24.30
1-221265-0	58, 58A, 58B, 58C, 141, 141A, 303, 223, 55, 55A, 55B, 142, 142A, 142B, 400	50F959	20.81	19.30

CRIMP PLUGS

5225974-5	59, 59A, 59B, 62, 62A, 62B	16M3998	33.72	31.28
-----------	----------------------------	---------	-------	-------

TWIST-ON PLUGS

Used with solid conductor cable. Not for applications where cable frequently moves or flexes.

5414265-3	58, 58B, 59, 59A, 59B	42K7183	4.15	3.57
-----------	-----------------------	---------	------	------

(8228)

AMP 50-OHM BNC PLUGS

- MIL-Style is built with teflon dielectric material
- Commercial-Grade connectors have polymethyltetraene or polypropylene dielectric material



Bayonet-locking coupling provides highly reliable, quick connect/disconnect coaxial connections and low VSWR. Fully interchangeable with comparable BNC UG/U connectors. Crimp versions are MIL-C-39012 Category B Type, many dual crimp versions meet or exceed all requirements in specifications MIL-C-39012, Class II, Category B. Order hand tools, listed in table below, separately on page 1039.

Mfg. Part No.	RG/U	Description	Crimp Type	Stock No.	Price Each	
					1-9	
2-5221128-1	174, 188, 188A, 316	...	Hex	42K8663	2.35	
5413959-3	174, 188, 188A, 316	Commercial-Grade Right Angle	Hex	42K9932	12.25	
5225395-7	174, 188, 188A, 316	MIL Style	Dual	42K7117	3.18	
5225398-7	174, 188, 188A, 316	MIL Style	Dual	42K8689	4.56	
5228979-7	174, 188, 188A, 316	MIL Style	Dual	42K7132	3.48	
1-5227079-6	174, 188, 188A, 316	Commercial-Grade	Dual	42K8643	1.95	
8-331350-0	174, 188, 188A, 316	MIL Style	Dual	52K3938	9.10	
2-5330061-1	174, 188, 188A, 316	MIL Style	Single	16M3889	14.85	
2-5330058-1	174, 188, 188A, 316	MIL Style	Single	16M2844	18.98	
2-5221128-3	179, 179A, 179B, 161, 187, 187A, Belden, 9221	Commercial-Grade	Hex	42K8664	2.34	
5225395-8		MIL Style	Dual	42K7118	2.79	
5225398-8		MIL Style	Dual	16M3230	6.08	
2-5227079-2		Commercial-Grade	Dual	42K8665	1.77	
9-331350-3		MIL Style	Dual	16M3468	9.38	
2-5329446-1		MIL Style	Single	16M2842	12.44	
2-5221128-7		Belden 9907, 89907	Commercial-Grade	Hex	16M2837	2.70
1-5225395-0		Belden 8218	MIL Style	Dual	71K0024	2.82
5221128-1		58, 58A, 58B, 58C	Commercial-Grade	Hex	42K8680	1.95
1-5221128-0		58, 58A, 58B, 58C	Commercial-Grade	Hex	42K8640	2.70
5413959-1	58, 58A, 58B, 58C	Commercial-Grade Right Angle	Hex	42K8715	10.93	
5225395-1	58, 58A, 58B, 58C	MIL Style	Dual	42K7115	3.36	
5225974-1	58, 58A, 58B, 58C	MIL Style	Dual	64K0078	25.23	
5227079-5	58, 58A, 58B, 58C	Commercial-Grade	Dual	42K8692	1.95	
5227079-9	58, 58A, 58B, 58C	Commercial-Grade	Dual	16M3239	1.95	
8-331350-0	58, 58A, 58B, 58C	MIL Style	Dual	52K3938	9.10	

➔ CONTINUED ➔

RF COAX MINIATURE

AMP 50-OHM BNC PLUGS (CONT.)

Mfg. Part No.	RG/U	Description	Crimp Type	Stock No.	Price Each	
					1-9	10-24
● 2-5329082-1	58, 58A, 58B, 58C	MIL Style	Single	16M2839	11.45	
2-331350-1	58, 58A, 58B, 58C	MIL Style	Dual	44F7871	7.20	
● 2-5329444-1	58, 58A, 58B, 58C	MIL Style	Single	42K6819	11.35	
● 5225395-3	223, 55, 55A, 55B	MIL Style	Dual	16M3225	3.36	
● 5227079-6	223, 55, 55A, 55B	Commercial-Grade	Dual	42K8693	1.70	
● 2-5329444-2	223, 55, 55A, 55B	MIL Style	Single	16M2841	11.93	
● 5225395-6	142, 142A, 142B, 400	MIL Style	Dual	42K7116	3.36	
2-331350-9	142, 142A, 142B, 400	MIL Style	Dual	44F8962	8.02	
● 5221128-2	124, 140, 210, 62, 62A, 62B, 59, 59A, 59B, Belden 9291, 9209, 9268	Commercial-Grade	Hex	16M3209	1.90	
● 1-5221128-1		Commercial-Grade	Hex	42K8641	2.70	
● 5225395-2		MIL Style	Dual	16M3224	3.32	
● 5227079-7		Commercial-Grade	Dual	42K8694	2.28	
● 5228979-6		Commercial-Grade	Dual	16M3247	3.48	
● 1-5227079-1		Commercial-Grade	Dual	16M2669	1.95	
331350		MIL Style	Dual	44F7873	6.30	
● 2-5329083-1		MIL Style	Single	16M2840	10.40	
● 2-5329445-1		MIL Style	Single	42K6820	11.68	
● 2-5225395-0	Belden 9104, 9112, 9167, 9259, 9266, Times FM-59	MIL Style	Dual	16M2838	4.49	
● 9-331350-4	Belden 8281, 9141, 9231, West. Elec. 724, 728, 3049	MIL Style	Dual	06M5109	11.39	
● 8-5227079-2	188DB	MIL Style	Dual	42K8829	1.84	
2-331350-6	180A, 195	MIL Style	Dual	46F1183	12.04	
● 6-5227079-1	142, 142A, 142B	Commercial-Grade	Dual	16M3393	3.18	
● 6-5227079-5	Belden 9290	Commercial-Grade	Dual	02M8530	4.43	
● 6-5227079-8	Belden 89907	Commercial-Grade	Dual	02M5375	2.12	
● 5225973-4	316	MIL Style	Dual	42K9927	27.97	

(8230)

AMP 50-OHM BNC JACKS



- MIL-Style dielectric material is teflon
- Commercial-grade dielectric material is polymethylpentene or polypropylene

Bayonet-locking coupling provides reliable, quick-connect/disconnect coaxial connections and low VSWR. Working voltage: 500Vrms. Dielectric withstanding voltage: 1500VAC. Frequency range: single crimp 0-2.5GHz; dual crimp, 0-4GHz. Crimp versions are MIL-C-39012 Category B Type. Order hand tools separately online.

Mfg. Part No.	RG/U	Description	Crimp Type	Stock No.	Price Each	
					1-24	1-9
● 5225396-2	124, 140, 210, 62, 62A, 62B, 59, 59A, 59B, Belden 9291, 9209, 9269	MIL Style	Dual	16M3226	6.33	
● 5225396-1	58, 58A, 58B, 58C	MIL Style	Dual	64K0080	5.97	
● 5413779-3	174, 188, 188A, 316	Commercial-Grade	Hex	61K2698	3.45	
● 5225396-7	174, 188, 188A, 316	MIL Style	Dual	16M3227	6.43	
● 2-5330062-1	174, 188, 188A, 316	MIL Style	Single	16M2845	21.23	
413771-6	Belden 89907, 9907	Commercial-Grade Bulkhead	Hex	50F1961	3.45	
2-331351-1	58, 58A, 58B, 58C	MIL Style	Dual	46F1186	11.20	
● 2-5329456-1	58, 58A, 58B, 58C	...	Single	16M2843	27.65	
● 6-311693-2	174, 188, 188A, 316	MIL Style Bulkhead	Dual	87K6918	10.71	
● 5228980-5	58, 58A, 58B, 58C	Commercial-Grade Bulkhead	Dual	16M3248	4.20	
● 5225398-3	223, 55, 55A, 55B	MIL Style Bulkhead	Dual	16M3228	5.28	
● 5225398-6	142, 142A, 142B	...	Dual	16M3329	4.40	
● 5225398-1	58, 58A, 58B, 58C	MIL Style Bulkhead	Dual	72K6837	7.35	
● 2-5330063-1	174, 188	...	Single	16M2846	16.53	

BULKHEAD SOLDER JACKS

Accepts 0.059" diameter wire. Includes lockwasher and jam nut. Order mfg. part no. 227223-1 bushing separately below.

Mfg. Part No.	Description	Stock No.	Price Each	
			1-24	1-9
● 5227715-3	Commercial-Grade	16M3242	3.75	
● 5227754-3	Commercial-Grade	16M3243	2.68	
● 5227754-2	Commercial-Grade	42K7128	2.70	
● 5227169-8	Commercial-Grade	42K9930	3.31	
● 5413515-8	Commercial-Grade	55K3159	4.28	
● 5227755-2	Commercial-Grade	42K7129	2.77	
● 5227222-6	Commercial-Grade	16M3241	3.34	

ACCESSORIES

Mfg. Part No.	Description	Stock No.	Price Each	
			1-9	1-24
● 227223-1	Insulating Bushing—0.585" Diameter	89F915	0.21	

▶ CONTINUED ▶

AMP 50-OHM BNC JACKS (CONT.)

ISOLATED BULKHEAD SOLDER JACKS

Mfg. Part No.	Stock No.	Price Each	
		1-9	10-24
● 5227726-1	42K7125	2.88	2.47
● 5227726-2	42K7126	3.05	2.62
● 5227726-3	42K7127	2.77	2.62
● 5227169-4	42K9928	2.99	2.72
● 5227716-3	06M6169	3.32	2.85

SEALED BULKHEAD SOLDER JACKS

Prevents moisture from entering interface from rear.

Mfg. Part No.	Stock No.	Price Each	
		1-24	25-49
● 5227426-1	42K7122	6.81	6.18

(8229)

AMP 50-OHM BNC COMMERCIAL PC BOARD/PANEL MOUNT JACKS



Just Added

226990-1

Mfg. Part No.	Mount	Body Material	Contact Plating	Mounting Posts	Mounting Height	Stock No.	Price Each	
							1-9	10-24
● 5226990-3	Right-Angle	White Valox	Gold	No	0.625"	16M3238	2.61	
● 5226990-1	Right-Angle	White Valox	Tin	No	0.625"	42K8691	2.76	
● 5415025-1	Right-Angle	Metal	Gold	No	0.432"	42K7188	11.15	
● 5227222-2	Vertical	Black Valox	Tin	Yes	1.375"	65K4421	2.90	
● 5413476-2	Vertical	Black Valox	Gold	Yes	1.375"	42K7173	7.93	
● 5227222-1	Vertical	White Valox	Tin	Yes	1.375"	37K6999	2.24	
● 5227222-3	Vertical	White Valox	Gold	Yes	1.375"	42K8700	2.24	
● 5227671-1	Vertical	Metal	Tin	Yes	1.375"	42K7124	2.83	
● 5227673-1	Vertical	Metal	Gold	Yes	1.375"	42K8702	2.58	
● 5413515-2	Right-Angle	Black Valox	Gold	Yes	0.519"	42K7174	3.33	
● 5227161-6	Right-Angle	Black Valox	Gold	Yes	0.625"	42K8697	2.24	
● 5227161-9	Right-Angle	Black Valox	Gold	Yes	0.625"	42K8699	2.13	
● 5227161-2	Right-Angle	Black Valox	Tin	Yes	0.625"	16M3240	2.43	
● 5227161-3	Right-Angle	White Valox	Gold	Yes	0.625"	42K8696	2.24	
● 5227161-7	Right-Angle	White Valox	Gold	Yes	0.625"	42K8698	2.24	
● 5227161-1	Right-Angle	White Valox	Tin	Yes	0.625"	42K8695	2.24	
● 5227677-1	Right-Angle	Metal	Gold	Yes	0.625"	42K8704	3.02	
● 5227661-1	Right-Angle	Metal	Tin	Yes	0.625"	42K8701	2.93	
● 5413879-1	Right-Angle	Metal	Gold	Yes	0.500"	42K8714	4.84	

(8236)

AMP 50-OHM BNC ADAPTERS



5413592-2



222165-2



221551-1



NA075P403

Mfg. Part No.	Description	Length	Stock No.	Price Each	
				1-9	10-24
● 221543-2	Tee Adapter (Jack-Plug-Jack)	1.031"	89F2924	13.06	
● 5413592-2	Tee Adapter (Jack-Plug-Jack)	1.300"	42K7180	6.90	
● 221988-1	Tee Adapter (Jack-Jack-Jack)	1.281"	89F2918	18.20	
222165-2	Right-Angle Adapter (Jack-Plug)	0.890"	89F2919	32.31	
● 221551-1	Feed-Thru Adapter (Jack-Jack)	1.281"	89F2897	8.85	
● NA075P403	Bulkhead Adapter (Jack-Jack)	1.500"	44F8965	18.19	
● 5228226-1	Bulkhead Adapter (Jack-Jack)	1.420"	42K7130	6.48	
● 5414666-1	Right Angle Adapter, Jack-Plug Intra-Series Coaxial	1.045"	16M3270	6.31	
● 5414105-1	Straight Adapter, Jack-Jack Intra-Series Coaxial	1.42"	16M4005	9.75	

▶ CONTINUED ▶

AMP 50-OHM BNC ADAPTERS (CONT.)

Mfg. Part No.	Description	Length	Stock No.	Price Each	
				1-9	10-24
● 5414414-1	Straight BNC Coaxial	1.42"	42K7186		3.80
● 222321-1	Straight Adapter, Jack-Plug Inter-Series Coaxial	1.321"	89F2930		17.26

(8239)

AMP 50-OHM BNC COMMERCIAL METALLIZED PC BOARD MOUNT JACKS

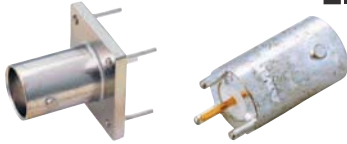

227699

5221123-2

Mfg. Part No.	Mounting	Contact Plating	Body Plating	Dielectric	Stock No.	Price Each		
						1-9	10-24	25-99
● 5227699-1	Vertical	Silver	Nickel	Valox	42K8705	3.42	3.20	2.99
● 5414305-1	Vertical	Silver	Tin	Valox	85K8340	5.03	4.33	3.82
● 5227699-2	Vertical	Gold	Nickel	Valox	42K8706	3.63	3.12	2.85
● 5221123-2	Vertical	Gold	Nickel	Valox	87K1027	3.83	3.28	3.04
● 5222006-1	Vertical	Gold	Nickel	Teflon	42K8686	4.02	3.48	3.08
● 5227699-3	Vertical	Tin	Nickel	Valox	42K8707	3.31	2.85	2.30
● 5413631-1	Right-Angle	Silver	Nickel	Polypropylene	42K7182	5.93	5.20	4.65
● 5414373-1	Right-Angle	Gold	Zinc	Polymethylpentene	16M4006	2.25	1.94	1.72
● 5413631-2	Right-Angle	Gold	Tin	Teflon	42K8710	6.90	5.94	5.25

(8238)

AMP 50-OHM BNC ACCESSORIES



330022

Mfg. Part No.	Description	Stock No.	Price Each		
			1-24	25-49	50-99
● 330022	Silver-Plated Jack Cover	87F4024	6.07	5.53	5.05
● 1-329631-2	Jam Nut for PC Board/Panel Mount Jacks	94F4615	0.20	0.19	0.18
● 1-329632-2	Lockwasher for PC Board/Panel Mount Jacks	94F4616	0.20	0.19	0.18
● GSR405S	Nylon Insulating Bushing, Outside Dia. 0.687" (17.45mm)	44F7883	0.67	0.64	0.60
● 222163-1	Polypropylene Insulating Bushing, Outside Dia. 0.575" (14.61mm)	88F5838	0.46	0.44	0.42
● 413453-1	Brass Straight Shorting Cap	05C0676	7.12	6.78	6.42

(8327)

AMP 75-OHM RF MINI-BNC CONNECTORS



Commercial-grade 75-ohm Mini-BNC RF connectors offer small size, allow 40% more interconnects in a given area than standard BNC connectors. Coaxial-terminating types have hex crimp.



Mfg. Part No.	Description	Cable Type	Stock No.	Price Each	
				1-9	10-24
● 1274563-1	Straight Plug	735A	57J4721		11.03
● 1274563-2	Straight Plug	734A	57J4722		10.11
● 1274563-3	Straight Plug	179	57J4723		11.50
● 1274566-1	Right-Angle Plug	735A	57J4724		12.27
● 1274566-2	Right-Angle Plug	734A	57J4725		12.05
● 1274566-3	Right-Angle Plug	179	57J4726		12.05
● 1274568-1	Straight Bulkhead Jack	735A	57J4727		7.94

▶ CONTINUED ▶

AMP 75-OHM RF MINI-BNC CONNECTORS (CONT.)

Mfg. Part No.	Description	Cable Type	Stock No.	Price Each	
				1-9	10-24
● 1274568-2	Straight Bulkhead Jack	734A	57J4728		7.18
● 1274568-3	Straight Plug	179	57J4729		7.19
● 1274571-1	Straight Jack, PCB	...	57J4730		4.86
● 1274572-1	Right-Angle Jack, PCB	...	57J4731		8.19
● 1274584-1	Right Angle Jack, Bulkhead PC	...	57J4732		9.63
● 1274663-2	Right-Angle Jack PCB	...	83K1017		13.92

(83240)

AMP 75-OHM COMMERCIAL BNC PLUGS



221185-8

413588

Mfg. Part No.	RG/U	Crimp Type	Dim. L	Stock No.	Price Each	
					1-24	25-49
● 5413588-2	59, 59A, 59B, 140, 210, 62, 62A, 62B, Belden 929, 92009, 9269, 89269	Hex	1.553"	16M3260	15.88	13.66
● 5413588-8	179, 179A, 179B, 187, 187A	Hex	1.553"	16M3261	17.00	14.62
● 5413589-1	Belden 88241	Hex	1.160"	16M3262	4.95	4.26
● 5413589-2	59, 59A, 59B, 140, 210, 62, 62A, 62B, Belden 929, 92009, 9269, 89269	Hex	1.160"	42K9931	4.02	3.71
● 5413589-3	Belden 8218, JIS 2.5C-2V	Hex	1.160"	16M4003	4.25	3.66
● 5413589-5	AT&T 728, Belden 8281, 9231, JIS 5C-2V	Hex	1.160"	14M4384	4.40	3.79
● 5413589-7	AT&T 734A	Hex	1.160"	42K7178	4.25	3.66
● 5413589-8	179, 179A, 179B, 187, 187A, 161, Belden 9221	Hex	1.160"	16M3263	3.24	2.91
● 5413589-9	Belden 8212, 9104, 9112, 9240, 9167, 9259, 9266	Hex	1.160"	42K7179	4.25	3.66
● 5221185-1	Belden 9248, 8228	Dual	1.010"	42K8681	2.49	2.25
● 5221185-2	59, 59A, 59B, 140, 210, 62, 62A, 62B, Belden 929, 92009, 9269, 89269	Dual	1.090"	42K8682	2.74	2.35
● 5221185-3	Belden 8281	Dual	1.120"	16M3210	3.14	2.99
● 5221185-5	Belden 8281, 9141, 9231, WE 724, 728, 3049	Dual	1.120"	16M3211	2.74	2.41
● 5221185-7	6, 6A	Dual	1.490"	11M0237	3.39	2.90
● 5221185-8	179, 179A, 179B, 187, 187A, 161, Belden 9221	Dual	1.140"	42K8683	2.74	2.35
● 5221185-9	Belden 8212, 9104, 9112, 9240, 9167, 9259, 9266	Dual	1.090"	42K8684	2.52	2.28
● 1-5221185-0	Belden 9145	Dual	1.090"	42K8642	2.86	2.52
● 1-5221185-8	AT&T 735A	Dual	1.140"	16M2665	3.29	2.89

(8329)

AMP 75-OHM COMMERCIAL BNC JACKS

Just Added



221221-2

222092-1

222117-1

Straight, bulkhead, or panel mount 75-ohm standard BNC jacks. Feature gold-plated center contact and nickel-plated body. Order mfg. part no. 354940-1 crimp tool and die sets separately on page 1039.

STANDARD JACKS

Mfg. Part No.	RG/U	Crimp Type	Dim. L	Stock No.	Price Each	
					1-9	10-24
● 5221221-5	179, 179A, 179B, 187, 187A, 161, Belden 9221	Dual	1.375"	42K9926	4.89	4.78
● 5413590-3	Belden 8218	Hex	1.450"	16M3264	10.07	8.56
● 5221199-2	59, 59A, 59B, 140, 210, 62, 62A, 62B, Belden 9291, 9209, 9269, 89269	Dual	1.200"	16M3212	4.43	3.76

▶ CONTINUED ▶

RF COAX MINIATURE

AMP 75-OHM COMMERCIAL BNC JACKS (CONT.)

Mfg. Part No.	RG/U	Crimp Type	Dim. L	Stock No.	Price Each	
					1-9	10-24
5221221-2	59, 59A, 59B, 140, 210, 62, 62A, 62B, Belden 9291, 9209, 9269, 89269	Dual	1.375"	16M3213	5.17	4.39
5413760-8	179, 179A, 179B, 187, 187A	Hex	1.300"	42K8712	5.24	4.45
5413760-9	Belden 9240, 9259, 9266	Hex	1.300"	16M3265	6.24	5.30
5221221-7	Belden 9240, 9259, 9266	Dual	1.375"	01M4993	4.69	3.98
5221199-5	179	Dual	1.200"	42K9925	5.68	4.88
5413590-8	179, 187	Hex	1.375"	65K8917	6.12	5.41

PANEL MOUNT JACK CONNECTORS - SOLDER TERMINATION

Mfg. Part No.	Description	Length	Stock No.	Price Each	
				1-24	25-49
5221244-1	Straight Jack	1.080"	73M8561	3.56	3.06
5414217-1	Vertical	1.260"	42K9933	7.40	6.47

PANEL MOUNT JACK CONNECTORS - PC BOARD TERMINATION

5222092-1	Right-Angle, Zinc Body	1.375"	42K8687	5.86	4.98
5414907-1	Right-Angle, Zinc Body, Low Profile	1.375"	42K8719	5.31	4.51
5415419-1*	Right-Angle, Zinc Body	1.375"	86K9631	6.50	5.53
5413194-1	Right-Angle, Valox Body, Low Profile, White	1.375"	42K7171	6.60	5.77
5413194-2	Right-Angle, Valox Body, Low Profile, Black	1.375"	42K7172	6.60	5.85
5222132-1	Vertical	3.480"	42K7101	7.17	6.52

*Tin plated center contact

PC BOARD MOUNT JACK CONNECTORS

5221336-3	Press Fit, Vertical	0.625"	42K8685	10.50	9.03
5222462-1	Press Fit, Vertical	0.810"	42K7102	4.17	3.67
5413558-1	Right-Angle	0.432"	42K7177	6.03	4.69
5414394-1	Straight Jack	0.655"	74K3505	4.80	4.31
6274291-1	Straight Jack	0.810"	40P9944	5.93	5.04

BNC ADAPTERS

5222117-1	Bulkhead Adapter (Jack-Jack)	1.420"	42K7100	9.07	8.68
-----------	------------------------------	--------	---------	------	------

(8328)

AMP BNC COMMERCIAL-GRADE TERMINATOR PLUGS

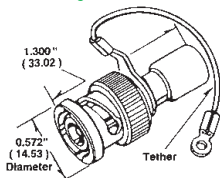

Feature nickel finish body, gold finish brass center contact and polyethylene dielectric.

221629-1

Mfg. Part No.	Resistor Specification	Description	Stock No.	Price Each		
				1-24	25-49	50-99
5221629-1	50 Ohm, 1 Watt	With Tether Strap	16M3993	8.80	7.57	6.69
5221629-4	50 Ohm, 1 Watt	With Tether Strap	16M3994	5.70	5.22	4.59
5221629-2	75 Ohm, 1 Watt	With Tether Strap	16M3215	16.65	14.32	12.66
5221629-5	75 Ohm, 1 Watt	Without Tether Strap	16M3216	9.72	8.40	7.40
5221629-6	93 Ohm, 1 Watt	Without Tether Strap	03M4542	8.48	7.33	6.46

(8320)

AMP PRO-CRIMPER™ III HAND TOOL



354940-1



PRO-CRIMPER™ III hand tool frame with interchangeable die set, ordered separately below, will crimp "O"-crimp BNC connectors. This versatile and reliable crimping tool requires less hand force to accomplish the correct crimp connection. Easy-grip handles.

Mfg. Part No.	Description	Stock No.	Price 1-4
354940-1	PRO-CRIMPER™ III Hand Tool (Frame/Handle Only)	96F6512	54.40

(8319)

HIGH PERFORMANCE TRUE 75 OHM CRIMP-CRIMP BNC CONNECTORS



Fig. 1

Fig. 2

- True 75 Ohm impedance end to end
- One piece spring alloy body/outer contact
- Strip/Crimp requirements consistent with all major industry providers
- Bayonet coupling provides a positive lock and allows for quick and easy connect/disconnects

Mfg. Part No.	Fig.	Description	RG/U	Stock No.	Price Each
					1-9
031-80101	1	Straight Plug	179, 187	88K0313	4.46
031-80102	1	Straight Plug	Belden 8218	88K0315	5.30
031-80103	1	Straight Plug	59	88K0316	4.02
031-80104	1	Straight Plug	734A	88K0317	5.27
031-80106	1	Straight Plug	174, 316	88K0321	5.30
031-80107	1	Straight Plug	179	88K0322	5.29
031-80108	1	Straight Plug	Belden 8281	88K0323	5.30
031-80109	1	Straight Plug	Belden 1694A	88K0324	4.29
031-80901	2	Right Angle Plug	179, 187	88K0328	18.11

*Bulk pack 100 pcs. (88659)

50-OHM BNC CABLE CONNECTORS

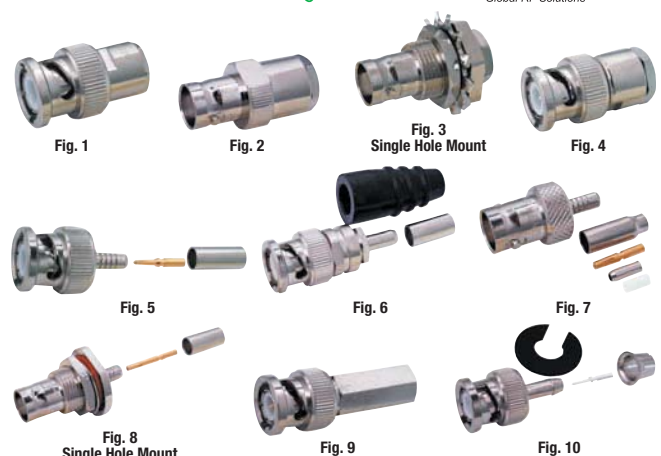

Lightweight connectors operate to 11GHz and yield low reflection up to 4GHz. Figs. 1-5 braid clamp types with solder contact. Fig. 6 Quicktrim® 3-piece crimp type plug assemble with solder or crimp contacts. Figs. 7 and 8 3-piece crimp type assemblies with braid crimp ferrule, crimp or solder contact. Figs. 9-11 3-piece crimp type assemblies with braid crimp ferrule, crimp or solder contact. Fig. 12 Quick assembly 3-piece units with spring braid ferrule, solder contact. Order tool and die sets separately on pages 1039-1040.

STRAIGHT PLUGS (CLAMP)

Mfg. Part No.	Fig.	MIL No.	RG/U	Stock No.	Price Each
					1-9
31-2	1	UG-88	58, 141, 142, 400	39F063	4.99
31-202*	1	UG-88C	55, 58, 141, 142, 223, 400	39F1018	3.98
31-12	1	UG-260	59, 62, 71, 140, 210, 302	73K1425	9.93
31-212*	1	UG-260B	59, 62, 71, 140, 210, 302	39F1027	4.95
31-212-1005	1	...	59 (20 GA Center Cond.)	38F1202	5.63
6775	1	UG-959	8, 9, 11, 213, 214	62K3482	22.81
6775-75	11, B1859, 7731, 8213, 9292	73K1480	30.68
69475	1	...	174, 179, 188, 316	40F6325	7.55
15875	1	...	178, 196	51F3824	7.61
31-3202	1	UG88E/U	55, 142, 223, 400	73K1433	13.77
31-3301	1	M39012/16-0101	55, 142, 223, 400	82K8893	8.12
16300	1	...	122, 180, 195, B1865A, B8218	83F6741	11.45
31-3302	...	M39012/16-0102	62C, 140B, 210	73K1435	18.64

RIGHT-ANGLE PLUG (CLAMP)

31-204*	...	UG-913	55, 58, 141, 142, 223, 400	39F1020	94.83
8525*	58, 58A, 58C, 141, 303, LMR 195, B7806A	73K1498	39.72

▶ CONTINUED ▶

50-OHM BNC CABLE CONNECTORS (CONT.)

JACKS (CLAMP)

Mfg. Part No.	Fig.	MIL No.	RG/U	Stock No.	Price Each
● 31-15	2	UG-261	59, 62, 71, 140, 210, B8241, B8263, B8279, B9209	39F066	11.68
● 31-5*	2	UG-89	55, 142, 223, 400	73K1440	5.57
● 86425*	174, 188A, 31, B7805A	73K1499	51.78

BULKHEAD JACKS (CLAMP)

● 31-206*	3	UG-909	58, 141, 142, 400	73K1427	7.38
● 86350	3	...	174, 179, 187, 188, 316	50F1606	13.41
● 31-207	3	UG-910/U	59, 62, 140, 210, B8241, B8263, B8279, B9209	73K1428	15.01

STRAIGHT PLUGS (QUICKTRIM®)

● 31-4541*	4	...	59, 62	38F1574	13.83
------------	---	-----	--------	-------------------------	-------

STRAIGHT PLUG (CRIMP)

● 31-325	5	...	122, 130, 195, B1865A, B8218	51F3825	6.81
● 31-321††	5	3-05††	59, 62, 140, 210, 302	39F1446	4.60
● 31-4321†	5	16-0015+	59, 62, 140, 210, 302	40F6318	6.18
● 68175†	5	...	59, 140, 210, 302	39F029	4.65
● 68175-1003	5	...	B9259	50F2443	5.10
● 68175-1004†	5	...	59, 62, 140, 210, 302	38F1200	5.23
● 68175-1005†	5	...	59 (20 GA Center Cond.)	38F1201	5.29
● 31-320‡	5	3-01, 3-03††	58, 141	39F1438	4.49
● 31-326‡	5	3-02, 3-04††	55, 142, 223	39F1442	5.50
● 31-4320‡	5	16-0013+	58, 141	73K1436	5.67
● 31-4326 (M39012/16-0014)‡	5	16-0014+	55, 142, 223	40F6320	4.55
● 31-4427‡	5	16-0503+	55, 142, 223, 400	89F2891	7.26
● 36775‡	5	...	58, 141	39F1072	5.01
● 36875‡	5	...	55, 142, 223, 400	39F1082	5.26
● 31-315**	5	...	174, 188, 316	40F6321	4.49
● 31-315-1005	5	...	316 Double Braid	93F1473	5.94
● 31-242**	5	...	Amphenol 21597 Times AA 6086	51F3836	7.22
● 31-320-1006	5	...	B9907, B89907	50F2447	4.99
● 31-321-1000 •	5	...	B8281	40F6322	6.20
● 31-70238 •	5	...	AT&T 735, 735A, B735A1	19C1698	2.56
● 31-70237 •	5	...	AT&T 734, 734A, B1505A	19C1697	2.50
● 31-6006 •	5	...	8X, LMR 240, B7808A	95B8151	10.07
● 31-351	6	...	58, 141	39F1042	14.31
● 31-359†	6	...	59, 62, 140, 210, 302	39F1044	39.30
● 31-371**	6	...	174, 179, 187, 188, 316	51F3837	12.28
● 31-30220-1**	6	...	58, 58A, 58C, 141, 303, LMR 195, B7806A	18C0403	16.52
● 31-5705**	58, 58A, 58C, 141, 303, LMR 195, B7806A	20C4369	28.25

RIGHT-ANGLE PLUGS (CRIMP)

● 31-335*	58, 141	39F1439	25.28
● 31-334*	55, 142, 223, 400	39F1443	25.99
● 31-316†	174, 188A, 316, B7805A	90B2190	26.94
● 31-6004-RFX	LMR 400, B9913, B9914	95B8149	8.70

JACKS (CRIMP)

● 68150	59, 62, 140, 210	51F3832	13.31
● 31-4327‡	7	17-0013+	58, 141	55M2223	10.47
● 31-317**	7	...	174, 179, 187, 188, 316	50F1607	10.91

BULKHEAD JACKS (CRIMP)

● 31-342‡	8	3-15, 3-17H	58, 141	39F1441	11.20
● 31-318**	8	...	174, 188, 316	51F3822	10.79
● 31-245	8	...	179, 187, B9221	51F3909	13.29

STRAIGHT PLUGS (SURETWIST®)

● 31-5137*	9	...	58, 58B	46F8023	7.18
● 31-5136*	9	...	59, 59A, 62, 62A	46F7815	5.57

STRAIGHT PLUGS (QUICK ASSEMBLY)

● 31-4700*	10	...	58	73K1438	6.25
● 31-4702*	10	...	59	82K8894	7.55

➤ CONTINUED ➤

50-OHM BNC CABLE CONNECTORS (CONT.)

RIGHT-ANGLE BULKHEAD JACK (PIN)

Mfg. Part No.	Fig.	MIL No.	RG/U	Stock No.	Price Each
● 31-5431-2010	54H2887	8.96

*UL recognized, preferred for new design; **Die set mfg. part no. 227-1221-9 and tool handle mfg. part no. 227-944; †Die set mfg. part no. 227-1221-11 and tool handle mfg. part no. 227-944; •Die set mfg. part no. 227-1221-32 and tool handle mfg. part no. 227-944; ‡Die set mfg. part no. 227-1221-13 and tool handle mfg. part no. 227-944; +M39012 P/N; ††M23329 P/N (8258)

50- AND 75-OHM BNC RECEPTACLES

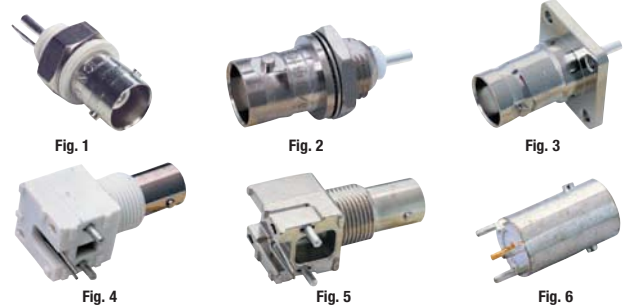

Order tool die sets separately on pages 1039-1040.

BULKHEAD RECEPTACLES

Mfg. Part No.	Fig.	Ohms	Description	MIL No.	Stock No.	Price Each
● 31-10	1	50	Isolated	...	38F1322	3.60
● 31-221	2	50	Thin Panel, Front Mount	UG-1094	39F075	2.05
● 31-2221	2	50	Front Mount	UG-1094A	39F3130	2.85
● 5575	2	50	Front Mount	UG-625	73K1471	5.05
● 31-236	2	50	Front Mount	UG-625B	39F1337	2.65
● 31-10-75	2	75	Front Mount	...	90F8488	6.84
● 31-238	2	50	Pressurized, Front Mount	UG-912	39F1339	36.53
● 31-102	2	50	Pressurized, Front Mount	UG-657	39F073	5.79
● 31-239	2	50	Pressurized, Front Mount	UG-657A/U	73K1431	7.86
● 31-3376+	2	50	Gold-Plated Contacts, Front Mount	21-0001	40F6330	9.68
● 31-4238+	2	50	Hermetic, Front Mount	24-0002	51F3829	26.42
● 31-5539-1010	...	50	Fork Pin	...	93F7513	5.88
● 31-5633	2	50	Fork Pin	...	73K1444	5.87
● 31-10-75RFXG2	2	75	Straight	...	19C3257	2.53
● 31-4890-1	2	50	Straight, Solder Cup	...	90F8467	20.36
● 31-4237	...	50	Straight, Solder Cup	M39012/24-0001	94F155	9.84
● 031-10-RFXG1	2	50	Straight, Solder Cup	...	19C1693	1.91
● 31-222	...	50	Angle, External Tooth Lock Washer	...	39F1034	69.16

PANEL RECEPTACLES

● 31-203	3	50	3-56 Tapped Flange, 0.500" Sq. Mtg. Holes	UG-290A	39F1019	7.00
● 4500	3	50	0.136" Tapped Flange Mounting Holes	UG-185/U	73K1465	34.36
● 5675	...	50	Angel Panel 4 hole Flange, 0.136" Diameter	UG-535/U	73K1472	28.85

PANEL RECEPTACLE PC PINS

● 18225	...	50	0.500" Sq. Mounting Holes	...	40F6329	19.24
---------	-----	----	---------------------------	-----	-------------------------	-------

PC BOARD MOUNT RIGHT-ANGLE BULKHEAD RECEPTACLES

● 31-5431*	4	50	Round Pins	...	73K1441	5.11
● 31-5538**	4	50	Round Pins	...	93F1501	5.02
● 31-5486*	4	50	Round Pins Low-Profile	...	90F8469	4.78
● 31-5540**	4	50	Round Pins Low-Profile	...	93F1503	4.61
● 31-5640+	5	50	Round Pins	...	93F7524	4.51
● 31-5637+	4	50	Round Pins	...	02H4683	3.73
● 031-5431-10RFX+	...	50	Round Pins	...	73K1442	2.94
● 31-5431-1010+	...	50	Right Angle, Fork Pin	...	93F7522	4.35
● 31-5640-1010	5	50	Fork Pins	...	93F7525	4.78
● 31-5486-1010	5	50	Fork Pins	...	93F7526	5.31
● 031-5538-10RFX	...	50	Fork Pins	...	73K1443	3.61

PC BOARD MOUNT VERTICAL BULKHEAD RECEPTACLES

● 31-5493*	...	50	Round Pins	...	93F1500	4.78
● 31-5539**	...	50	Round Pins	...	93F1502	6.11

➤ CONTINUED ➤

RF COAX MINIATURE

50- AND 75-OHM BNC RECEPTACLES (CONT.)

PC BOARD MOUNT RECEPTACLES

Mfg. Part No.	Fig.	Ohms	Description	MIL No.	Stock No.	Price Each	
						1-9	100+
● 31-5329	6	50	Jack/3 Legs 0.040" Post Terminal, Zinc Body	...	89F2885	6.20	

ACCESSORIES

Mfg. Part No.	Description	Stock No.	Price Each			
			1-9	10-24	25-99	100+
● 31-105	Precision Bead-Contact Sub-Assembly	73K1424	21.60	19.89	18.42	17.16

*Isolated, white Valox housing; **Isolated, black Valox housing; +Metal housing (8277)

75-OHM CRIMP-CRIMP BNC CONNECTORS (CONT.)

Mfg. Part No.	Fig.	Description	RG/U	Die Set*	Stock No.	Price Each	
						1-9	100+
● 31-70008-1000	...	BNC Plug (BNC-T1)	ATT. 734A	...	93F1505		6.32
● 31-70018	2	Bulkhead Recep. (BNC-T1)	89F2868		11.19
● 31-70019	3	Straight Adapter (J-J)	89F2869		5.50
● 31-70020	4	Bulkhead Adapter (J-J)	89F2870		29.14

*Die sets fit mfg. part no. 227-944 tool handle order separately on page 1040, except mfg. part no. CTL items which contain handle and die set (8188)

3

50-OHM BNC COAXIAL NETWORKING CONNECTORS



Amphenol® RF Global RF Solutions



Mfg. part no. 31-5800 for Thinned/Ethernet systems using PVC or plenum cable. Mfg. part no. 31-5900 for IBM/Arnet systems using PVC or plenum cable. Each plug features three-piece crimp-crimp termination and is supplied with two ferrules: straight for PVC cable and neck down type for plenum cable. Feature durable astroplate finish and gold-plated contacts that snap in place. Mfg. part no. CTL-1 hex crimp tool is available; go online or call. Mfg. part no. 31-208-RFX networking jack-plug-jack T-adapter is also available; order separately on page 1039.

Mfg. Part No.	RG-U	Stock No.	Price Each	
			1-9	100+
● 31-5800	58, 58A, 58B, 58C, 141, Plenum 58, Thinned, Belden 9907, 89907, Comscope 2104K, 2135, 3104	66F9250	2.26	
● 31-5900	59, 62, 59 20GACC, Plenum 59 & 62, Belden 1515A, 8212, 8221, 8241, 8241A, 8241F, 8263, 8279A, 9100, 9209, 9209A, 9240, 9244, 9259, 9274, 9275, 9659, 1426A, 82108, 88241, 89259, 82259, 1506A, AT&T 734A, Comscope 5553, 2020K, 3037V, 2249K	66F9251	2.63	
● 31-71008-1RFX	59	01C1987	1.64	
● 31-71065	6 Double Braided	09C9601	8.20	
● 31-71011	52, 62, 140, 210, Belden 8241, 8263, 8279, 9209	93F1521	25.58	

(8300)

75-OHM CRIMP-CRIMP BNC CONNECTORS



Amphenol® RF Global RF Solutions

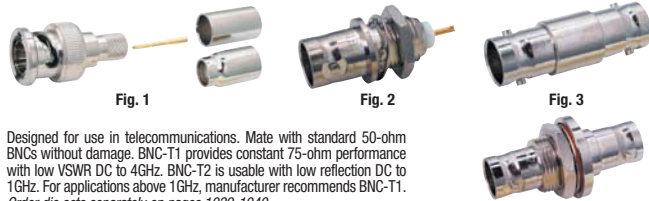

Designed for use in telecommunications. Mate with standard 50-ohm BNCs without damage. BNC-T1 provides constant 75-ohm performance with low VSWR DC to 4GHz. BNC-T2 is usable with low reflection DC to 1GHz. For applications above 1GHz, manufacturer recommends BNC-T1. Order die sets separately on pages 1039-1040.

Mfg. Part No.	Fig.	Description	RG/U	Die Set*	Stock No.	Price Each	
						1-9	100+
● 31-70000	1	BNC Plug (BNC-T1)	Belden 89248 or PL-6	227-980-3	89F2857	5.87	
● 31-70008	1	BNC Plug (BNC-T1)	59	227-980-1	89F2858	6.74	
● 31-70013	1	BNC Plug (BNC-T1)	179	227-980-7	89F2863	9.36	
● 31-71003	...	BNC Plug (BNC-T2)	59, 62, 71, 140, 210	...	93F1515	23.04	
● 31-71008	1	BNC Plug (BNC-T2)	59	CTL-1	90F8483	3.66	
● 31-71008-1000	1	BNC Plug (BNC-T2)	59 (20GA Center Cond.)	CTL-1	93F1517	4.26	
● 31-71008-2000	1	BNC Plug (BNC-T2)	Plenum 59	...	93F1518	5.24	
● 31-71013	1	BNC Plug (BNC-T2)	179	CTL-2	90F8485	4.39	
● 31-71032	1	BNC Plug (BNC-T2)	Belden 8281, 88281	CTL-2	93F1526	3.72	
● 31-71033	1	BNC Plug (BNC-T2)	Belden 8218	CTL-2	93F1527	3.28	
● 31-71035	1	BNC Plug (BNC-T2)	Plenum 59 (20 Ga. CC)	...	01F994	6.84	
● 31-71064	1	BNC Plug (BNC-T2)	RG-6 Mfg. Part No.; Belden 9248	...	01F996	5.24	

▶ CONTINUED ▶

31 SERIES RFX™ 50-OHM AND 75-OHM BNC CONNECTORS



Amphenol® RF Global RF Solutions

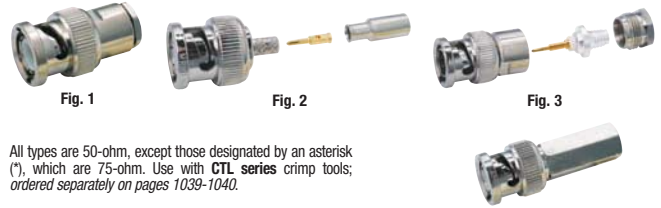

All types are 50-ohm, except those designated by an asterisk (*), which are 75-ohm. Use with CTL series crimp tools; ordered separately on pages 1039-1040.

Mfg. Part No.	Fig.	RG/U	Stock No.	Price Each			
				1-9	10-24	25-99	100-499
● 31-2-RFX	1	58, 141, 142	93F1398	2.20	1.85	1.54	1.42
● 31-212-RFX	1	59, 62	93F1403	2.52	2.30	2.12	1.96
● 31-5998-RFX	1	LMR 400, Belden 9913	95B8144	5.32	4.86	4.48	4.15
● 31-5999-RFX	1	8X, Belden 9258	95B8145	6.13	5.61	5.16	4.78
● 31-242-RFX	2	179, 187	93F1414	1.95	1.78	1.62	1.50
● 31-315-RFX	2	174, 188, 316	93F1416	1.85	1.55	1.31	1.21
● 31-320-RFX	2	58, 141, 142	97B2386	1.48	1.27	1.15	1.06
● 31-321-RFX	2	59, 62	93F1419	1.83	1.52	1.41	1.31
● 31-71000-RFX*	2	Belden 9248	93F1439	2.54	2.32	2.14	1.98
● 31-321-10RFX*	2	Belden 8218, 88281	19C3283	2.08	1.87	1.70	1.56
● 31-5558-RFX*	2	6, 212, Belden 89248, 9290	92B6424	2.50	2.28	2.11	1.95
● 31-71008-RFX*	2	59, 62	19M4827	1.88	1.70	1.59	1.49
● 31-71013-RFX*	2	179, 187	93F1445	1.75	1.59	1.46	1.35
● 68175-5RFX	2	59, 20 Ga. Conductor	93F1395	1.66	1.47	1.12	1.07
● 31-4541-RFX	3	59, 62	93F1429	4.08	3.72	3.41	3.14
● 31-5136-RFX	4	59	93F1431	2.03	1.85	1.56	1.45
● 31-5137-RFX	4	58, 58A, 58C, 141, 303, LMR 195, Belden 7806A	93F1432	2.03	1.85	1.56	1.45
● 31-317-RFX	4	174, 188A, 316, Belden 7805A	30C1216	2.42	2.22	2.03	1.89
● 31-71014-RFX	...	179, 187, Belden 9221	93F1446	1.99	1.81	1.67	1.53

(8213)

31 SERIES RFX™ 50-OHM AND 75-OHM BNC BULKHEAD JACKS



Amphenol® RF Global RF Solutions



All jacks are 50-ohm, except those designated by an asterisk (*), which are 75-ohm. Use with CTL series crimp tools, order separately on page 1039.

Mfg. Part No.	RG/U	Stock No.	Price Each			
			1-9	10-24	25-99	100-499
● 31-318-RFX	174, 188, 316	93F1417	3.12	2.83	2.46	2.30
● 31-342-RFX	58, 141, 142	93F1422	3.02	2.76	2.55	2.35
● 31-343-RFX	59, 62, 140, 210	93F1423	3.74	3.40	3.11	2.87
● 31-71011-RFX*	59	93F1443	3.51	3.19	2.93	2.70
● 31-71016-RFX*	179	93F1447	2.99	2.73	2.51	2.32

(8214)

RF COAX MINIATURE

31 SERIES RFX™ BNC PANEL AND BULKHEAD RECEPTACLES



Amphenol® RF
Global RF Solutions



Fig. 1



Fig. 2



Fig. 3

Receptacles are front mount bulkhead, except mfg. part no. 31-203-RFX, which is front or rear mount panel. All types are 50Ω, except mfg. part nos. with suffix 75RFX, which denotes 75Ω.

Mfg. Part No.	Fig.	Stock No.	Price Each			
			1-9	10-24	25-99	100-499
● 31-10-RFX	1	93F7577	2.19	1.86	1.54	1.44
● 31-203-RFX	2	93F1401	2.71	2.46	2.26	2.09
● 31-221-75RFX	3	93F1412	1.67	1.37	1.19	1.07
● 31-221-RFX	3	92B6175	1.53	1.38	1.23	1.13

(8215)

31 SERIES RFX™ BNC PC BOARD RECEPTACLES



Amphenol® RF
Global RF Solutions

Feature gold-plated contacts except mfg. part no. 31-5329-51-RFX which has silver-plated contacts.



Mfg. Part No.	Impedance	Stock No.	Price Each			
			1-9	10-24	25-99	100-499
● 31-5329-52RFX	50-Ohm	93F7520	2.19	1.97	1.80	1.64
● 31-5329-51-RFX	50-Ohm	93F7519	1.72	1.54	1.40	1.29
● 31-5329-72RFX	75-Ohm	93F7554	1.79	1.63	1.50	1.39

(8219)

31 SERIES RFX™ 50-OHM AND 75-OHM BNC RIGHT-ANGLE PLUGS AND GROUNDING LUG



Amphenol® RF
Global RF Solutions



Fig. 1



Fig. 2

Use with CTL series crimp tools, order separately on page 1039.

Mfg. Part No.	Fig.	Impedance (Ω)	Cable RG/U	Stock No.	Price Each			
					1-9	10-24	25-99	100-499
● 31-335-RFX	1	50	58, 58A, 58C, 141, 303, 2MR195, Belden 7806A	93F7553	4.49	4.10	3.50	3.26
● 31-71010-RFX	1	75	59, 62, 140, 210, Belden 8241, 8263, 8279, 9209	73K1447	5.83	5.32	4.90	4.55

GROUNDING LUG

Mfg. Part No.	Fig.	Stock No.	Price Each			
			1-9	10-24	25-99	100-499
● 31-10152-RFX	2	93F1438	0.46	0.39	0.32	0.29

(8216)



eQuotes

Retrieve and process Newark quotes online from our website under MY ACCOUNT eSuite. Log in or register today.

(148833)

RFX™ BNC ADAPTERS



Amphenol® RF
Global RF Solutions



Fig. 1



Fig. 2



Fig. 3



Fig. 4



Fig. 5



Fig. 6



Fig. 7

Mfg. Part No.	Fig.	Description	Stock No.	Price Each		
				1-9	10-24	25-99
● 31-9-RFX	1	Right-Angle Jack/Plug, 50-Ohm	93F7576	4.19	3.81	3.22
● 31-28-RFX	2	Jack/UHF Plug	73K1432	40.66	36.34	32.17
● 31-208-RFX	3	Jack/Plug/Jack Tee, 50-Ohm	93F1402	4.80	4.08	3.09
● 31-216-RFX	4	Jack/N Plug	93K0375	14.51	11.31	10.94
● 31-217-RFX	5	Plug/N Jack	73K1429	22.65	20.70	19.06
● 31-218-RFX	6	Plug/Plug, 50-Ohm	93F1406	3.02	2.74	2.26
● 31-218-75RFX	6	Plug/Plug, 75-Ohm	93F1407	3.47	3.17	2.92
● 31-219-RFX	7	Jack/Jack, 50-Ohm	93F1408	3.44	3.00	2.53
● 31-220G-RFX	...	Jack/Jack Bulkhead with Gasket, 50-Ohm	93F7596	3.69	3.14	2.64
● 31-220N-RFX	...	Jack/Jack Bulkhead without Gasket, 50-Ohm	93F1409	3.04	2.74	2.30
● 31-220N-75RFX	...	Jack/Jack Bulkhead without Gasket, 75-Ohm	93F1410	3.04	2.76	2.46
● 31-4803-1101	...	Jack/Jack, 50-Ohm	93F1482	15.57	13.91	12.32
● 31-4803-75	...	Jack/Jack, 75-Ohm	50B8959	12.04	10.99	10.12
● 21900	...	Plug/Jack/Jack Tee, 50-Ohm	51F3828	97.78	87.40	77.37

(8218)

RFX™ RESISTOR TERMINATED BNC MALE CAPS



Amphenol® RF
Global RF Solutions

BNC caps resistor terminated, 5% 1 watt. Impedance available: 50, 75 or 93 ohms. Feature nickel-plated brass body, silver-plated brass male contact. Delrin dielectric material.



Mfg. Part No.	Impedance	Stock No.	Price Each			
			1-9	10-24	25-99	100-499
● 46650-51RFX	50-Ohm	93F1392	1.87	1.70	1.44	1.38
● 46650-75RFX	75-Ohm	93F1393	1.99	1.83	1.63	1.50
● 46650-93RFX	93-Ohm	93F1394	3.15	2.78	2.45	2.26

(8270)

RFX™ BNC CONNECTORS



Amphenol® RF
Global RF Solutions



Fig. 1



Fig. 2



Fig. 3

50-ohm BNC plugs features miniature bayonet lock units. Crimp-type outer and press fit inner cable attachments. Nickel-plated brass body, gold-plated brass male contacts. Delrin dielectric material. Frequency range: 0-4GHz. Voltage rating 500V peak. Use with CTL crimp tools; order separately on page 1039.

RFX™ 50-OHM BNC PLUG

Mfg. Part No.	Fig.	RG/U	Stock No.	Price Each			
				1-9	10-24	25-99	100-499
● 36650-3RFX	1	Plenum 58	97B4392	1.73	1.58	1.29	1.19
● 31-5556-RFX	2	59	93F1433	2.03	1.85	1.70	1.56

(8275)

RFX™ 50-OHM BNC JACK

● 36800-RFX	3	58, 141, 142	93F7573	1.60	1.43	1.34	1.15
-------------	---	--------------	---------	------	------	------	------

RF COAX MINIATURE

BNC ADAPTERS, CAPS, AND ACCESSORIES



Mfg. Part No.	Fig.	MIL No.	Description	Stock No.	Price Each
31-218	1	UG-491A	Adapter (Plug-Plug)	39F1031	9.73
31-219	2	UG-914	Adapter (Jack-Jack)	39F1032	4.98
31-9	3	UG-306	Angle Adapter, (Plug-Jack)	39F071	12.26
31-209	3	UG-306A	Angle Adapter, (Plug-Jack)	39F1071	13.41
31-2208	4	UG-274B/U	Tee Adapter, (Jack-Plug)	39F1080	13.74
3170036	4	UG-274B/U	Tee Adapter, (Plug-Jack-Jack)	88F4834	68.23
31-8	4	UG-274	Tee Adapter (Jack-Plug-Jack)	73K1448	19.10
31-208	4	UG-274A	Tee Adapter (Jack-Plug-Jack)	39F1024	9.69
47000	6	UG-414	Panel Adapter (Jack-Jack)	73K1469	56.77
4525	7	...	Bulkhead Adapter (Jack-Jack)	51F3827	21.13
31-220N	7	...	Adapter Bulkhead Mount (Jack-Jack), Nonsealed	39F1033	7.74
31-220H	7	UG-492A	Bulkhead Adapter (Jack-Jack), Sealed	90F6319	8.08
31-3220	7	UG-492D	Bulkhead Adapter (Jack-Jack), Sealed	73K1434	12.28
31-4803	7	...	Bulkhead Adapter (Jack-Jack) Isolated	38F757	11.28
31-6	8	CW-123	Male Cap with Chain	39F1000	3.86
31-6-RFX	8	...	Male Cap with Chain	19C3347	2.03
31-17	8	CW-159	Male Cap Shorting Contact with Chain	73K1426	5.54
46650-51	9	...	50-Ohm, 1 Watt Resistor Male Cap without Chain	73K1466	15.00
46650-75	9	...	75-Ohm, 1 Watt Resistor Male Cap without Chain	73K1467	11.13
35650-51	9	...	50-Ohm, 1/2 Watt Resistor Male Cap with Chain	73K1454	16.38
4700-51	9	...	50-Ohm, 1/2 Watt, Male, Cap and Chain	73K1468	28.22
35650-75	9	...	75-Ohm, 1/2 Watt Resistor Male Cap with Chain	73K1455	16.51
31-759	10	...	Shield Ground Lug (IBM 2245373)	39F1035	0.70
31-5652	11	...	Nickel-Plated Hex Nut for PC Board Bulkhead Receptacle	93F7516	0.76
31-5653	12	...	Nickel-Plated Lockwasher for PC Board Bulkhead Receptacle	93F7517	0.75
31-9-75	Adapter (Plug-Jack), 75-Ohm	01F992	13.46
31-9-75RFX	Angle Adapter (Jack-Plug)	19C3356	4.59
31-4803-RFX	Adapter, (Jack-Jack)	19C3313	3.28
31-220N-75	Bulkhead Adapter (Jack-Jack)	93F1472	11.32

V-BITE® PC EDGE MOUNT BNC COAXIAL CONNECTORS



- Low profile, 0.270" high FMS
- Anti-rotational
- VSWR 1.15:1
- Patented V-Bite® snaps into PC board
- Surface mount center contact

BNC JACKS WITH TEFLON FOR REFLOW SOLDER

Mfg. Part No.	Fig.	Impedance (Ω)	Contact Material	Contact Finish	Stock No.	Price Each
361V504ER	1	50	Phosphor Bronze	Gold	80K6280	4.62 4.18
361V704ER	1	75	Phosphor Bronze	Gold	80K0251	4.93 4.46

CONTINUED

V-BITE® PC EDGE MOUNT BNC COAXIAL CONNECTORS (CONT.)

BNC JACKS WITH POLYETHYLENE INSULATOR

Mfg. Part No.	Fig.	Impedance (Ω)	Contact Material	Contact Finish	Stock No.	Price Each
361V509E	1	50	Phosphor Bronze	Tin	80K0248	4.20 3.80
361V709E	1	75	Phosphor Bronze	Gold	80K0253	4.88 4.41

BNC THREADED JACK WITH TEFLON FOR REFLOW SOLDER

361V504ET	2	50	Phosphor Bronze	Gold	80K0247	4.98 4.51
-----------	---	----	-----------------	------	---------	-----------

BNC THREADED FLANGE JACK WITH TEFLON INSULATOR

361V504EFT	3	50	Phosphor Bronze	Gold	80K0246	5.48 4.96
361V704EFT	3	75	Phosphor Bronze	Gold	80K0249	6.13 5.55

ACCESSORIES

Mfg. Part No.	Description	Stock No.	Price Each
361KNT	Knurled Nut	80K0243	0.76 0.69 0.62 0.56
BD36100	Hex Wrench for 361KNT	79K5735	218.33 197.50 176.66 158.33

75-OHM BNC BROADCAST CONNECTORS FOR BELDEN CABLE

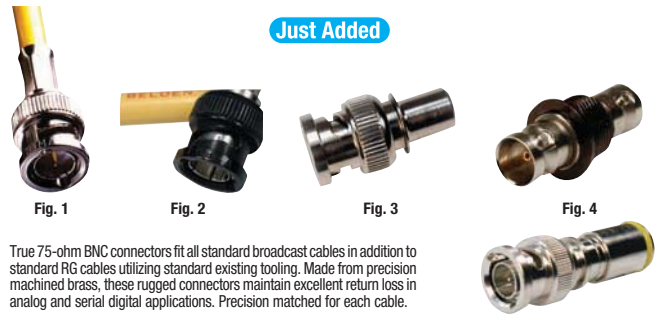

Just Added

True 75-ohm BNC connectors fit all standard broadcast cables in addition to standard RG cables utilizing standard existing tooling. Made from precision machined brass, these rugged connectors maintain excellent return loss in analog and serial digital applications. Precision matched for each cable.

Mfg. Part No.	Fig.	Body Style	RG Cable Type	Stock No.	Price Each
SBC1505A	1	Straight Plug	Belden 1505A	83K0829	3.47 3.13
SBC1694A	1	Straight Plug	Belden 1694A	83K0830	3.50 3.15
SBC1855A	1	Straight Plug	Belden 1855A	83K0831	3.47 3.13
SBC7731A	1	Straight Plug	Belden 7731A	83K0832	3.98 3.59
SBC8218	1	Straight Plug	Belden 8218	83K0833	3.47 3.13
SBC8241	1	Straight Plug	59	83K0834	3.47 3.13
SBC8281	1	Straight Plug	Belden 8281	83K0835	3.22 2.90
HBC1505A*	2	Straight Plug	Belden 1505A	83K0825	3.36 3.03
HBC1694A*	2	Straight Plug	Belden 1694A	83K0826	3.36 3.03
HBC310X075	3	Straight Terminator	...	83K0827	7.56 6.81
HBC335R744	4	Straight Bulkhead Adapter, Jack-Jack	...	83K0828	14.08 12.68
KCC1505B	5	Straight Plug	59	19P9283	5.11 4.60
KCC1694B	5	Straight Plug	6	19P9286	5.11 4.60
KCC1855B	5	Straight Plug	59 Mini	19P9291	5.11 4.60

CRIMP TOOLS

Mfg. Part No.	For Use With	Die Size	Stock No.	Price Each
BD17900	High Definition BNC Connectors	...	79K5729	291.39
BDHD100	Serial Digital BNC Connectors	0.324, 0.255, 0.068, 0.042	26M8958	305.49
BDHD200	Serial Digital BNC Connectors	0.255, 0.213, 0.178, 0.100, 0.068, 0.042	26M8959	305.49
BDKC6000	Broadcast Grade Crimp Connectors	...	19P8368	164.49

*High definition (87999)

Expert technical support

Chat online to our team of engineers, or connect to them through your representative.

(148838)

RF COAX MINIATURE

FRONT MOUNT BNC BULKHEAD JACKS

Just Added



Fig. 1



Fig. 2



Fig. 3

These jacks are held into the panel by a hex-nut and lock washer. All units feature nickel plated, brass bodies, and gold phosphor-bronze contacts.

Mfg. Part No.	Fig.	Body Style	Bushings Color	Features	Stock No.	Price Each	
						1-49	50-99
● 326R515	1	Straight Bulkhead Jack	White	Isolated	80K0189	2.71	2.51
● 326R515BL	2	Straight Bulkhead Jack	Blue	Isolated	80K0190	3.85	3.57
● 326R515RD	3	Straight Bulkhead Jack	Red	Isolated	80K0192	3.85	3.57

(142227)

BNC PC BOARD RIGHT-ANGLE JACKS



Fig. 1



Fig. 2



Fig. 3



Fig. 4

50-ohm versions have been approved by most of the U.S. manufacturers of LAN cards, and the 75-ohm is used in high definition video applications which require the use of a true 75-ohm connector. Contact material: phosphor bronze. Contact finish: gold.

STANDARD PROFILE WITH POSTS

Mfg. Part No.	Fig.	Impedance (Ω)	Body Material	Stock No.	Price Each		
					1-24	25-49	50-99
● 364A595	1	50	White Valox	80K0272	2.65	2.40	2.15
● 364M595	3	50	Nickel/Zinc	80K0312	3.70	3.35	2.99
● 364A795	1	75	White Valox	80K0285	2.65	2.40	2.15

LO-PROFILE WITH POSTS

● 364A595BL	2	50	White Valox	80K0275	2.65	2.40	2.15
● 364M595L	4	50	Nickel/Zinc	80K0313	3.88	3.51	3.14
● 364A795BL	2	75	White Valox	80K0288	2.86	2.59	2.31

ACCESSORIES

Mfg. Part No.	Description	Stock No.	Price Each		
			1-24	25-49	50-99
● 364NT	Jam Nut	80K0327	0.84	0.76	0.68

(88000)

DUAL BNC THREADED RIGHT-ANGLE PC JACKS



Fig. 1



Fig. 2



Fig. 3

Contact material: Phosphor bronze. Contact finish: gold.

Mfg. Part No.	Fig.	Impedance (Ω)	Body Material	Stock No.	Price Each		
					1-24	25-49	50-99
● 364A2595	1	50	White Valox	80K0261	8.86	8.01	7.17
● 364M2595	2	50	Metal	80K0305	11.95	10.81	9.67
● 364A2795	1	75	White Valox	80K0265	10.01	9.06	8.10
● 364M2795	2	75	Metal	80K0308	14.15	12.80	11.45
● 3M64M2795	3	75	Metal	79K9850	19.63	17.76	15.88

ACCESSORIES

Mfg. Part No.	Description	Stock No.	Price Each			
			1-24	25-49	50-99	100-249
● 364KNT	Knurled Nut	80K0300	0.95	0.86	0.77	0.69
● 364NT	Jam Nut	80K0327	0.84	0.76	0.68	0.61
BD36400	Hex Wrench for 364KNT	79K5736	218.33	197.50	176.66	158.33

(88001)

50-OHM BNC STRAIGHT COAXIAL PLUGS



KC-59-557-M06



50-OHM BNC STRAIGHT COAXIAL PLUGS

Mfg. Part No.	Contacts	For RG/U Cable	Mil. No M39012/	Stock No.	Price Each 1-499
● 755-129-9	Crimp	174, 179, 187, 188	...	88K3075	7.44
● KC-59-284	...	174, 188, 188A, 316	...	94F5260	26.18
● KC-59-557-M06	Crimp	174, 188, 188A, 316, 179A, 179B, 187, 187A	...	44F8478	9.93
● 755-112-5	Crimp	142, 233, 400	16-0014	92H2845	4.08
● 755-112-9	Crimp	142, 223, 400	...	65K4942	4.38
● 755-114-9	Crimp	58, 141	...	72J6548	4.14
● 755-122-5	Crimp	58, 141	16-0504	98H0160	5.99

BNC WITHIN SERIES ADAPTERS

Mfg. Part No.	Description	Stock No.	Price Each	
			1-499	500-999
● KC-99-54	Straight Bulkhead Adapter, Jack-Jack	44F8509	26.60	24.38
● UG-914/U	Straight Adapter, Jack-Jack	44F8514	10.66	9.77
2029-17-9 QD	Straight Adapter, Jack-Jack	99K5547	5.48	5.02

(8863)

TRUE 75-OHM HDTV BNC CONNECTORS



- Voltage Rating: 500V RMS
- Contact Resistance: Center 0.0014-Ohm, Outer 0.002-Ohm
- Insulation Resistance: 5000MΩ
- Flammability Rated: UL94V-0 (Center Conductor Insulator)



BNC Plugs

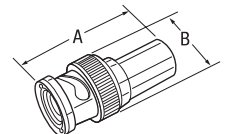

BNC Plugs Dimensions

2065 series BNC connectors are TRUE 75-ohm connectors designed to terminate the most commonly utilized coaxial cable in the broadcast industry. Meet the industry's stringent HDTV standards and feature a full crimp design. Field installable with ratchet-style crimp tool and die sets; order separately below.

75-OHM BNC PLUGS

Mfg. Part No.	For Cable	Dimensions Inches (mm)		Use Die Set	Stock No.	Price Each 1-99
		A	B (Dia.)			
● 2065-2-9	Belden 1505A, 1506A, 9259	1.21 (30.7)	0.57 (14.5)	KTH-2261	96B7245	2.88
● 2065-15-9	Belden 8281	1.10 (28.0)	0.57 (14.5)	KTH-2119	63K4285	5.30
● 2065-7-9	59	1.21 (30.7)	0.57 (14.5)	KTH-2261	96B1295	4.87
● 2065-10-9	Belden 1694A, 1695A	1.22 (31.0)	0.57 (14.5)	KTH-2255	94B9461	3.01
● 2065-11-9	Belden 1855A, 1865A	1.22 (31.0)	0.57 (14.5)	KTH-2025	96B1230	2.98
2065-28-9	179, 187, Belden 9221	1.21 (30.7)	0.56 (14.5)	KTH-2258	99K5549	6.60

CRIMP HAND TOOL AND DIE SETS

Mfg. Part No.	Description	Stock No.	Price Each 1-4
● KTH-1000	Ratchet-Style Crimp Hand Tool	44F8469	374.84
● KTH-2001	Crimp Die For Use With RG-55, 58, 141, 142, 233	44F8470	264.51
● KTH-2004	Crimp Die For Use With Belden 7731A, 8213	44F8480	268.77
● KTH-2025	Crimp Die For Use With Belden 1855A, 1865A	96B1229	223.55
● KTH-2255	Crimp Die For Use With Belden 1694A, 1695A	96B5987	238.45
● KTH-2261	Crimp Die For Use With Belden 1505A, 1506A, 8241, 9209A, 9259	91B7857	251.99

(75877)

TRI-LOC® CONNECTORS, CRIMP TOOL AND DIE SETS



Plug



Jack

TRI-LOC® 75-OHM TRIAXIAL CAMERA CONNECTORS

Feature low loss between camera and control units. Contacts can be either crimped or soldered and have a locating shoulder that positions them in the connector. The inner braid is crimped and the outer braid is of the conventional "comb-out" type allowing rapid and reliable terminations. The contacts have a non-conductive anti-shock safety tip.

▶ CONTINUED ▶

RF COAX MINIATURE

TRI-LOC® CONNECTORS, CRIMP TOOL AND DIE SETS (CONT.)

preventing personnel from making contact with the current carrying conductor. Connectors are completely sealed and weatherproof when engaged. This rugged construction and its weather-resistant TR-5® finish makes them ideally suited for outdoor use.

Plugs and Jacks					Crimp Die Sets		
Mfg. Part No.	Description	RG Cable Type	Stock No.	Price Each 1-4	Mfg. Part No.	Stock No.	Price Each 1-4
7705-2	Std. Plug	Belden 1856A, 1857A, 9267	16F8179	205.59	KTH-2002	44F8471	171.77
7703-2	Std. Jack	Belden 1856A, 1857A, 9267	88F4089	118.04	KTH-2002	44F8471	171.77
7705-3	Std. Plug	Belden 9232	16F8180	205.40	KTH-2041	94F5281	180.32
7703-3	Std. Jack	Belden 9232	16F8182	117.63	KTH-2041	94F5281	180.32

KTH-1000 CRIMP TOOL

Ratchet type crimp tool utilizes interchangeable die sets; order separately above. Tool does not release until crimp is complete. Frame made of heavy-duty lightweight aluminum.

Mfg. Part No.	Stock No.	Price Each 1-4
KTH-1000	44F8469	374.84

(75878)

RF COAXIAL RECEPTACLES



KV-79-15

1704-1

KA-71-02

KN-79-70

FRONT MOUNT

Mfg. Part No.	Description	Cable Type	Mil. No. 39012/	Stock No.	Price Each 1-99
KC-79-07-M06	BNC Straight Receptacle, PCB Thru Hole	58	...	44F8494	21.17
KC-79-108†	BNC Straight Bulkhead Receptacle	58	24-0002	50F1442	29.50
KC-79-67	BNC Straight Bulkhead Receptacle	44F8550	10.72
KC-79-274-M06	BNC Straight Receptacle, PCB Thru Hole	93B5234	13.00
KC-79-107	BNC Straight Bulkhead Receptacle	...	24-0001	94F5264	27.94
UG-1094/U	BNC Straight Bulkhead Receptacle	58	...	44F8518	11.09
KC-79-35*	BNC Straight Bulkhead Receptacle	58	...	44F8551	10.79
KC-79-106	BNC Straight Bulkhead Receptacle	58	21-0002	44F8513	10.07
KC-79-302-M06	BNC Straight Bulkhead Receptacle	58	...	44F8501	22.97
KV-79-15	MHV Straight Receptacle, Bulkhead	46F6043	23.20
1064-1	High Voltage Straight Receptacle, Bulkhead (10KV)	98F9727	20.29
1764-1	High Voltage Straight Receptacle, Bulkhead (20KV)	98B0082	66.57
1704-1	SHV Straight Bulkhead Receptacle, Front Mounting	46F6040	9.09
1704-2	SHV Straight Bulkhead Receptacle, Rear Mounting	93F6328	23.92
1704-3-9	SHV Straight Receptacle, Panel Mount (6KV)	92C6715	11.06
KA-71-02	TNC Straight Bulkhead Receptacle	...	31-0001	90F6329	8.58
1964-1-9	BNC Straight Receptacle, Crimp	66F3876	28.76

PANEL MOUNT

Mfg. Part No.	Description	Cable Type	Mil. No. 39012/	Stock No.	Price Each 1-499
KN-79-70	N Straight Receptacle	...	04-0002	90F1978	16.92
1707-1	SHV Straight Receptacle, 1.79"L x 0.44"W	46F6041	22.10
KC-79-07	BNC Straight Receptacle, PCB Thru Hole	98F8015	21.05
KC-79-237 M06	BNC Right Angle Receptacle, PCB Thru Hole	96B1005	21.63
KC-19-152	BNC Straight Bulkhead Receptacle	174, 179, 187, 188, 316	...	46F6037	12.89
KC-79-131	BNC Straight Bulkhead Receptacle	44F8500	9.09

*Male, brass contact; †Hermetically sealed (8663)

VOLTREX® BRAND CRIMP-ON BNC CONNECTORS



VOLTREX® brand

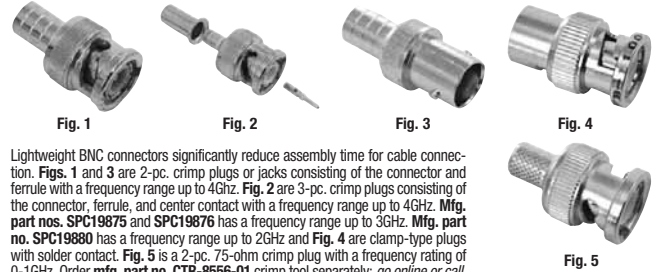

Lightweight BNC connectors significantly reduce assembly time for cable connection. Figs. 1 and 3 are 2-pc. crimp plugs or jacks consisting of the connector and ferrule with a frequency range up to 4GHz. Fig. 2 are 3-pc. crimp plugs consisting of the connector, ferrule, and center contact with a frequency range up to 4GHz. Mfg. part nos. SPC19875 and SPC19876 has a frequency range up to 3GHz. Mfg. part no. SPC19880 has a frequency range up to 2GHz and Fig. 4 are clamp-type plugs with solder contact. Fig. 5 is a 2-pc. 75-ohm crimp plug with a frequency rating of 0-1GHz. Order mfg. part no. CTR-8556-01 crimp tool separately; go online or call. 50-OHM BNC CRIMP PLUGS

Mfg. Part No.	Fig.	RG/U	Jacket O.D. (in.)	Stock No.	Price Each 1-24	Price Each 25-49
SPC20102	1	58*	0.195 - 0.210	82K9782	2.11	1.89
SPC15233	1	58*, 141, 142	0.195 - 0.210	79K4832	2.17	1.69
SPC15346	1	59, 62	0.220 - 0.250	79K4936	4.55	3.64
SPC15193	1	174, 188, 316	0.085 - 0.105	79K4796	2.48	1.93
SPC4211	1	Belden 8281	0.272 - 0.307	84N1541	4.27	3.39
SPC4219	2	6	0.265 - 0.280	84N1549	4.61	3.67
SPC4220	2	6	0.265 - 0.280	84N1550	3.79	3.01
SPC19877	2	179	...	83K0852	1.76	1.59
SPC19878	2	59	...	83K0853	4.61	3.67
MC23569	2	316	...	96M8853	2.01	1.61

50-OHM BNC RIGHT ANGLE CRIMP PLUGS

MC23566	...	58	...	96M8850	2.07	1.85
MC23574	...	142	...	96M8858	2.03	1.74

50-OHM MIL-TYPE COMMERCIAL BNC PLUGS

1581	2	55, 142, 223	0.200 - 0.215	92N3405	3.30	2.64
SPC20097	2	58*	0.185 - 0.210	82K9777	3.26	2.77
1580	2	58TFE	0.175 - 0.191	92N3404	3.30	2.64
SPC20098	2	59	0.220 - 0.250	82K9778	2.03	1.74

50-OHM MULTIFUNCTION BNC PLUGS

SPC20100	2	174	0.085 - 0.105	82K9780	3.22	2.73
----------	---	-----	---------------	---------	------	------

50-OHM BNC CRIMP JACKS

CP89-1	3	58*	0.195 - 0.210	44N3642	6.04	4.95
CP89-2	3	59, 62	0.220 - 0.250	44N3643	3.65	2.91
MC23572	...	174	...	96M8856	2.65	2.18

50-OHM BNC CLAMP PLUGS

SPC4276	4	8	0.395 - 0.415	84N1265	17.04	14.00
1551	4	58, 58A, 58C, 141, 141A, 400*	0.185 - 0.205	92N3397	4.19	3.85

75-OHM BNC CRIMP PLUGS

SPC4212	2	6	0.265 - 0.280	84N1542	4.37	3.48
SPC20099	2	59	0.220 - 0.250	82K9779	1.48	1.33
MC23553	2	59	...	96M8837	2.01	1.61
1584	2	59, 62TFE	0.195 - 0.205	92N3408	3.47	3.24
SPC19876	2	179	...	83K0851	7.67	6.28
MC23597	2	179	...	96M8881	2.01	1.61
SPC19880	2	Belden 8218	...	83K0855	3.94	3.14
MC23596	2	Belden 8218	...	96M8880	1.84	1.48
SPC20101	2	Belden 8281	0.280 - 0.305	82K9781	3.35	2.84
1553	5	Belden 8281	0.295 - 0.315	92N3399	4.97	4.07

75-OHM BNC CRIMP JACKS

13-15-1 TSS RG179U	3	179	...	26M5810	1.79	1.62
--------------------	---	-----	-----	---------	------	------

*For RG 58 (0.319") use mfg. part no. CTD-8572-02 die set or mfg. part no. 1738 crimping tool (8801)

Huge Expanded Selection of Semiconductors

Go online to find new technologies and proven solutions from world-class and specialist suppliers.

(148843)

VOLTREX® BRAND TWIST-ON BNC CONNECTORS

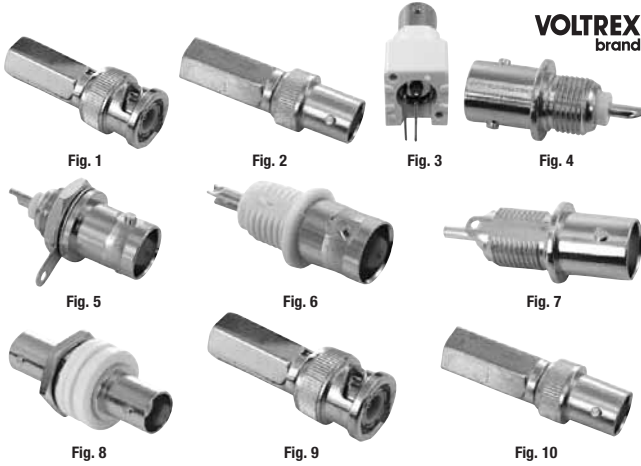

Lightweight BNC plugs and jacks significantly reduce assembly time for cable connection because there is no soldering or special tools required for termination. **Figs. 1-3** are designed for solid wire except for **mfg. part nos. CPFI-88SW-1**, and **CPFI-88SW-2** designed for stranded wire. **Figs. 4-10** are interchangeable with all BNC units having a 2-stud bayonet locking coupling mechanism that meets military specifications MIL-C-39012. Frequency rating: 0-4GHz.

50-OHM BNC TWIST-ON PLUGS

Mfg. Part No.	Fig.	RG/U	Jacket O.D.	Stock No.	Price Each
● SPC4222	1	6	0.270 - 0.280"	84N1552	3.71
● CPFI-UG88-1*	1	58	0.185 - 0.205"	32N1100	3.62
● SPC20103	1	58, 62	0.220 - 0.250"	82K9783	4.83

75-OHM BNC STRAIGHT TWIST-ON PLUG FOR RG6

● SPC4229	1	6	0.270 - 0.280"	84N1559	6.36
-----------	---	---	----------------	---------	------

50-OHM BNC TWIST-ON JACKS

● CPFI-UG89-2	2	59, 62	0.220 - 0.250"	81N5438	4.27
---------------	---	--------	----------------	---------	------

RIGHT-ANGLE PC BOARD MOUNT JACK

● 1552	3	...	0.550-0.560"	92N3398	4.81
--------	---	-----	--------------	---------	------

50-OHM BULKHEAD JACKS

Mfg. Part No.	Fig.	RG/U	Jacket O.D.	Stock No.	Price Each
● SPC20096	4	...	0.277-0.377"	82K9776	2.02
● SPC4274**	4	84N1263	2.16
● SPC15415	5	...	0.383-0.483"	79K4997	2.69
● SPC15466	6	...	0.328-0.428"	79K5040	5.64
● CP-1094A/ST-50	7	...	0.304-0.312"	90N3218	2.38

50-OHM BNC CHASSIS MOUNT JACKS

● 1578+	8	...	0.521-0.621"	92N3402	9.19
---------	---	-----	--------------	---------	------

*Commercial grade; **75-ohm; +Dual/isolated

Type	Fig.	Description	RG/U	Jacket O.D.	Stock No.	Price Each
● CPFI-UG88-1	9	BNC Plug	RG-58	0.185-0.205"	32N1100	3.62
● SPC15345*			RG-59 & RG-62	0.220-0.250"	79K4935	3.91
● CPFI-UG89-2	10	BNC Jack	RG-59 & RG-62	0.220-0.250"	81N5438	4.27

(8878)

50-OHM AND 75-OHM COAXIAL CONNECTORS

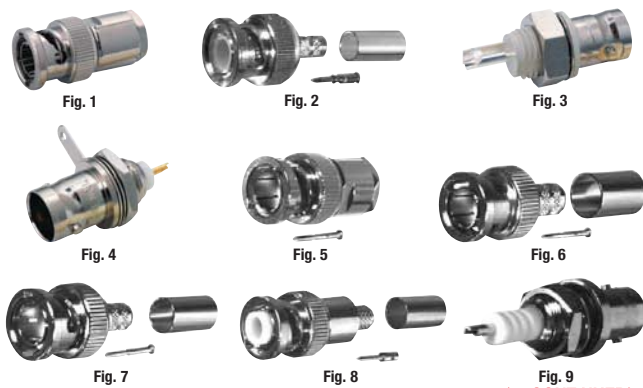

▶ CONTINUED ▶

50-OHM AND 75-OHM COAXIAL CONNECTORS (CONT.)

50-OHM BNC PLUGS (GOLD-PLATED BRASS CONTACTS)

Mfg. Part No.	Fig.	RG/U	Coaxial Termination	Connector Mounting	Insulation	Stock No.	Price Each
● SPC11222	1	58, 142	Clamp	Cable	Delrin	34C5623	7.46
● SPC11223	1	174	Clamp	Cable	Teflon	34C5624	9.07
● 13-01-3 58U	1	58	Clamp	Cable	Teflon	21M5080	2.57
● 13-01-3 TGZ RG174U	1	174	Clamp	Cable	Teflon	26M5786	1.21
● MC23571	1	178	Clamp	Cable	Teflon	96M8855	2.39
● 13-10-1 TSS RG58U*	2	58	Crimp	Cable	Teflon	26M5802	1.66
● SPC11224	2	58	Crimp	Cable	Teflon	34C5625	5.05
● MC23600	2	178	Crimp	Cable	Teflon	96M8884	2.06
● MC23606	...	174	Crimp	Cable	Teflon	96M8890	3.65
● 13-10-1 179U TGN/Z	...	179	Crimp	Cable	Teflon	25M0426	131.67

50-OHM BNC JACKS (GOLD-PLATED BRASS CONTACTS)

● SPC11227	3	174, 188, 188A, 316	Solder	Cable	ABS	34C5628	4.99
● SPC11228	4	...	Solder	Cable	Teflon	34C5629	6.17
● SPC11229	4	...	Crimp	Cable	Teflon	34C5630	6.71
● MC23557	3	...	Solder	Panel	...	96M8841	1.78
● 13-25-12 TGN	4	...	Solder	Panel	Teflon	26M5825	1.58
● 13-25	4	...	Solder	Panel	...	26M5822	1.84
● 13-28	4	...	Solder	Panel	...	19M5205	2.16
● MC23576	...	174	Clamp	Panel	Teflon	96M8860	4.38

75-OHM BNC PLUGS (GOLD-PLATED BRASS CONTACTS)

● 13-01-3 TGN UR70	1	UR70	Clamp	Cable	Teflon	26M5785	1.21
● SPC11204	5	59	Crimp	Cable	Delrin	34C5609	4.43
● SPC11205	5	59	Crimp	Cable	Teflon	34C5610	2.22
● 13-10-1 RG59	6	59	Crimp	Cable	Teflon	26M5799	1.69
● SPC11209	6	6	Crimp	Cable	Teflon	34C5614	4.93
● SPC11210	7	179	Crimp	Cable	Teflon	34C5615	1.57
● 1553	6	Belden 8281	Crimp	Cable	Delrin	92N3399	4.97
● MC23608	7	Belden 1855A	Crimp	Cable	Teflon	96M8892	1.84
● MC23609	6	Belden 1694A	Crimp	Cable	Teflon	96M8893	1.84

75-OHM BNC JACKS (GOLD-PLATED BRASS CONTACTS)

● SPC4274	3	...	Solder	Panel	Delrin	84N1263	2.16
-----------	---	-----	--------	-------	--------	---------	------

MEDIUM-HIGH VOLTAGE 5KVDC PLUGS (GOLD-PLATED BRASS CONTACTS)

● SPC11220	8	59, 62, 71, 140, 210	Crimp	Cable	Teflon	34C5621	10.64
------------	---	----------------------	-------	-------	--------	---------	-------

MEDIUM-HIGH VOLTAGE 5KVDC JACKS (GOLD-PLATED BRASS CONTACTS)

● SPC11221	9	...	Solder	Cable	Teflon	34C5622	13.36
------------	---	-----	--------	-------	--------	---------	-------

STRAIGHT BULKHEAD ADAPTER

Mfg. Part No.	Impedance (Ohms)	Convert From	Convert To	Stock No.	Price Each		
● MC23562	50	BNC Jack	BNC Jack	96M8846	1-49	50-99	100-249
● MC23595	75	BNC Jack	BNC Jack	96M8879	3.30	2.71	2.49
					3.38	2.77	2.54

* Silver-plated contacts. (68615)

CRIMP-ON BNC CONNECTOR KITS



Connectors reduce installation time. At the center of the preassembled unit is a self-energizing contact between 2 polyethylene insulators. To install, push the trimmed center conductor home and complete the termination by sliding the braid crimp ferrule over the end of the unit and crimp. **Mfg. part no. 8411-UG88/1** kit contains: 25 RG-59/U connectors, universal coax stripper, and a full-cycle ratchet-type crimp tool. **Mfg. part no. 8411-UG88/2** kit contains: 25 RG-59/U and RG-62/U connectors, universal coax stripper, and a full-cycle ratchet-type crimp tool.

Mfg. Part No.	Description	Stock No.	Price Each
8411-UG88/1	RG-59/U Crimp-On BNC Kit	23N3623	153.72
8411-UG88/2	RG-59/U, -62 Crimp-On BNC Kit	23N3624	157.94

(8802)

RF COAX MINIATURE

EASY-ON™ BRAND 30-PC. UNIVERSAL COAXIAL ADAPTER KIT



Mfg. part no. 8589-0863 30-piece universal adapter kit allows mix and match of any 2 male or female coaxial fittings. Each connector has a common end and a universal end. Simply choose the 2 common connector ends needed and screw them together with the universal adapter. Kit contains 6 universal adapters, 2 each of the following: BNC male adapters, BNC female adapters, N male adapters, N female adapters, SMA male adapters, SMA female adapters, TNC male adapters, TNC female adapters, UHF male adapters, UHF female adapters, mini-UHF male adapters and mini-UHF female adapters. All parts are silver plated with gold contacts and Teflon® insulation. Features handy zippered storage case.



Mfg. Part No.	Stock No.	Price Each
		1-9
● 8589-0863	16N2745	249.38

(8845)

50-OHM BNC CONNECTORS



Mfg. Part No.	Body Style	Description	RG/U	Stock No.	Price Each
					1-24
● 73100-0090	Right Angle Receptacle	Bulkhead, PCB, Filtered	...	32M0737	7.31
● 73100-0105	Right Angle Receptacle	PCB	...	97C7196	1.65
● 73100-0131	Right Angle Receptacle	Bulkhead, PCB, White	...	44K0028	2.81
● 73100-0153	Straight Jack	Vertical PCB	...	96K4119	3.78
● 73100-0167	Right Angle Receptacle	Bulkhead PCB, Black, Board Lock Legs	...	67K2694	2.23
● 73100-0178	Straight Jack	Cable, Crimp termination	179, 187, Belden 9221	32M0740	2.53
● 73100-0195	Straight Bulkhead Jack	Solder Pot Contact	...	32M0741	4.47
● 73100-0223	Right Angle Bulkhead Jack	Filter PCB, Black	...	32M0742	3.69
● 73100-0491	Straight Plug	Cable, Crimp	58	32M0744	2.28
● 73103-5001	Straight Plug	Cable	174, 316	32M0745	2.12
● 73104-5003	Straight Plug	Non-captive	58	32M0746	2.12
● 73115-5003	Straight Receptacle	Bulkhead	...	32M0747	3.65
● 73137-5003	Right Angle Receptacle	Panel Isolated, Black PBT Housing	...	63M5044	2.01
● 73151-5001	Right Angle Adapter, Plug-Jack	Gold Contact	...	32M0748	7.93
● 73171-1680	Straight Jack	Cable, Crimp	174, 188, 316	32M0753	4.70
● 73174-0073	Straight Plug	Cable, Crimp	174, 188, 316	32M0761	4.48
● 73174-0093	Straight Plug	Captive Contact	58, 141, 303	32M0762	2.67
● 73277-0040	Straight Bulkhead Jack	10 KV, Solder Pot Contact	...	32M0786	40.62
● 73415-1960	Dust Cap	Dust Cap, No Chain	...	32M0810	3.31

(90505)

New products added weekly

See the newest products, technologies and suppliers on our website.

(148886)

75-OHM BNC CONNECTORS



Mfg. Part No.	Body Style	Description	RG/U	Stock No.	Price Each
					1-9
● 73100-0067	Right Angle Receptacle	Bulkhead, PCB, Black	...	32M0732	2.81
● 73100-0069	Right Angle Receptacle	Bulkhead, PCB, White	...	32M0733	2.85
● 73100-0070	Right Angle Receptacle	Bulkhead, PCB, Black	...	32M0734	2.85
● 73100-0071	Right Angle Receptacle	Bulkhead, PCB, White	...	32M0735	3.39
● 73100-0080	Right Angle Receptacle	Bulkhead, PCB, Diecast	...	32M0736	2.64
● 73171-0700	Right Angle Receptacle	Bulkhead, PCB, Low Profile	...	32M0751	3.83
● 73171-0730	Straight Plug	Cable, Solder/Crimp	6	32M0752	4.64
● 73171-1900	Straight Jack	Vertical Receptacle	...	78H0854	1.79
● 73171-2600	Straight Receptacle	Bulkhead	...	32M0754	8.08
● 73174-0113	Straight Plug	Captive Contact	59, 62, 71	69K7719	3.00
● 73415-3980	Right Angle Dual Jack	PCB Mount, Stacked	...	32M0822	6.50

(90506)

75Ω BNC BULKHEAD JACKS



Fig. 1

Fig. 2

FEED-THRU RECESSED BULKHEAD JACKS

Mfg. Part No.	Fig.	Description	Stock No.	Price Each
				1-9
● NBB75DFI*	1	Isolated	27C7968	10.78
● NBB75DFIB*	1	Isolated, Black	27C7969	10.55
● NBB75DFG*	1	Grounded	27C7970	10.45
● NBB75DFGB*	1	Grounded, Black	27C7972	11.09

FEED-THRU BULKHEAD JACKS

● NBB75FI	2	Isolated	27C7974	8.55
● NBB75FG	2	Grounded	27C7971	9.02
● NBB75FI-M	2	Isolated, Metal Threads	34C9334	22.00

*Uses same hole cutout size as Neutrik brand "D" series connectors (65993)

50Ω BNC COAXIAL CONNECTORS AND ADAPTERS

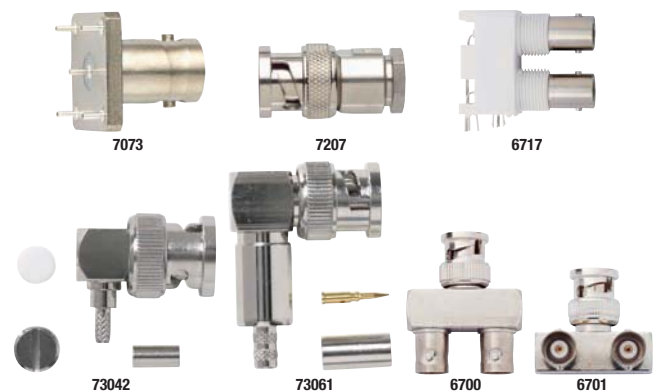

▶ CONTINUED ▶

50Ω BNC COAXIAL CONNECTORS AND ADAPTERS (CONT.)

STRAIGHT JACKS

Mfg. Part No.	Connector Mounting	Coaxial Termination	RG/U	Stock No.	Price Each	
					1-24	25-49
● 5344	Cable	Crimp	58, 58A, 58C, 141, 141A	87F073	5.18	4.83
● 7073	PC Board	Solder	...	23J7895	7.32	6.84
● 4578	PC Board	Solder	...	46F2207	4.23	3.95

STRAIGHT PLUGS

● 5307	Cable	Solder	174, 179A, 179B, 187, 187A, 188, 188A, 316	94F1517	8.83	8.25
● 7207	Cable	Crimp	58, 141, 223, 303	23J7926	6.83	6.38
● 5285	Cable	Crimp	58, 58A, 58C, 141, 141A	94F1515	2.86	2.67
● 4488	Cable	Clamp	142, 142A, 142B, 22358, 58A, 58C, 141, 141A	44F5330	3.43	3.20
73043	Cable	Crimp	8, 9, 11, 213, 214	08R6348	5.73	...

RIGHT ANGLE JACKS

● 4788	PC Board	Solder	...	46F2206	10.89	10.17
● 6717	PC Board	Solder	...	61H3198	14.87	13.89

RIGHT ANGLE PLUGS

73042	Cable	Crimp	174, 188, 316	08R6347	6.03	...
73061	Cable	Crimp	58, 141	08R6364	18.21	...

ADAPTERS

Mfg. Part No.	Body Style	Convert From	Convert To	Stock No.	Price Each	
					1-24	25-49
● 3283	Straight	BNC Jack	BNC Jack	30F1401	5.03	4.70
● 3533	Straight	BNC Plug	BNC Plug	30F1414	3.43	3.20
● 4119-50	Straight	BNC Plug	BNC Jack	35F1017	38.08	35.57
● 3286	Straight	BNC Jack	UHF Plug	39F3635	11.12	10.39
● 3287	Straight	UHF Jack	BNC Plug	39F3630	9.85	9.20
● 3846	Straight	BNC Jack	BNC Jack	39F3631	8.49	7.93
● 3844	Straight	BNC Jack	TNC Plug	50F1474	17.09	15.97
● 3847	Straight	BNC Jack	BNC Jack	89F363	20.99	19.61
● 4119-600	Straight	BNC Plug	BNC Jack	78B1736	61.59	57.53
● 6700	Straight	BNC Plug	BNC Jack Jack	61H3182	16.88	15.76
● 3534	Right Angle	BNC Jack	BNC Plug	39F3629	9.40	8.78
● 6701	Right Angle	BNC Plug	BNC Jack Jack	61H3183	19.26	17.99
● 3284	Tee	BNC Jack	BNC Jack Jack	30F1409	14.58	13.62
● 3285	Tee	BNC Plug	BNC Jack Jack	30F1402	6.39	5.97
● 4896	Tee	BNC Plug	BNC Jack Jack	46F2208	14.56	13.60

TERMINATORS AND CAPS

Mfg. Part No.	Description	Stock No.	Price Each	
			1-24	25-49
● 3840-50	Terminator Plug	44F5328	7.45	6.96
● 5085	Plug Shorting Cap	50F1473	5.05	4.71
● 3839	Jack Dust Cap w/ Chain	77B2417	2.62	2.45

(8803)

50Ω BNC ATTENUATORS AND DIN ADAPTERS



50-OHM BNC ATTENUATORS

Mfg. Part No.	Description	Stock No.	Price Each	
			1-24	25-49
● 4108-3DB	BNC Attenuator, 3db	10M4325	73.84	68.97
● 4108-6DB	BNC Attenuator, 6db	10M4326	76.06	71.05
● 4108-10DB	BNC Attenuator, 10db	10M4323	76.06	71.05
● 4108-20DB	BNC Attenuator, 20db	10M4324	73.84	68.97

7/16 DIN ADAPTERS

Mfg. Part No.	Description	Stock No.	Price Each	
			1-24	25-49
● 6256	7/16 DIN Male-to-"N" Male Adapter	02B1780	128.84	120.35
● 6257	7/16 DIN Male-to-"N" Female Adapter	02B1781	114.68	107.12
● 6260	7/16 DIN Female-to-"N" Female Adapter	02B1784	107.04	99.98

7/16 DIN ADAPTERS

Mfg. Part No.	Description	Stock No.	Price Each	
			1-24	25-49
● 6256	7/16 DIN Male-to-"N" Male Adapter	02B1780	128.84	120.35
● 6257	7/16 DIN Male-to-"N" Female Adapter	02B1781	114.68	107.12
● 6260	7/16 DIN Female-to-"N" Female Adapter	02B1784	107.04	99.98

(90521)

75Ω BNC CONNECTORS AND ADAPTERS

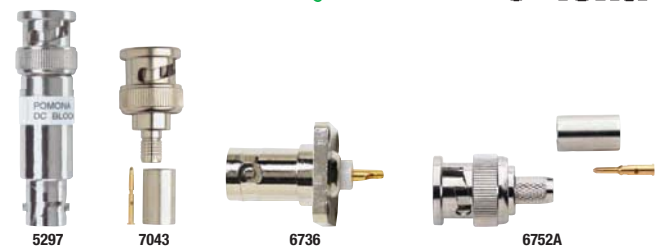

Pomona BNC connectors and adapters are precision machined with tarnish resistant nickel plating, and designed to 75Ω for your broadcast applications.

BNC COAXIAL

Mfg. Part No.	Description	Stock No.	Price Each	
			1-24	25-49
● 3840-75	BNC Male Resistor Termination Adapter	44F5326	12.52	11.71
● 4119-75	BNC Feed-Thru Termination	46F2212	57.70	53.98
● 5286	BNC Male Cable Plug, Crimp Style for RG-59, -62, -71, -210 Cable	84F926	3.76	3.52
● 6702A	BNC Male Connector for RG59 B/U 20 AWG High-Definition	73K9990	1.98	1.85
● 6703A	BNC Male Connector for RG6 B/U 18 AWG High-Definition	73K9992	2.09	1.95
● 6704A	BNC Male Connector for RG59 B/U 23 AWG High-Definition	73K9994	1.36	1.27
● 6705	Isolated BNC Female-to-Female Panel Adapter for HDTV	61H3187	14.29	13.37
● 6718	Right Angle Dual BNC Female PCB Mount, White Valox Case	61H3199	16.07	15.04
● 6746A	BNC Male Compression Style, Field Inst. for RG 59, 59A, 59B, 62, 210 Cable	02J8346	2.23	2.08
● 6752A	BNC Male Crimp for RG59, 59A, 59B, 62, 210 Cable	02J8350	3.46	3.23
● 7035	BNC Male Crimp for RG 55A, 142, 142A, 223, 400 Cable	23J7877	4.91	4.60
● 7040	BNC Male Crimp for RG 174, 188, 188A, 316 Cable	23J7881	5.72	5.35
● 7042	BNC Male Coaxial for Belden 1407B, 1417B, 1164B 1167B, 1418B, 1146B, 11865A Cable	23J7883	3.65	3.41
● 5297	BNC Male-to-Female with DC-Blocking Series Capacitor, 1000pF, 600VDC	46F2376	32.46	30.37

BNC ADAPTERS AND CONNECTORS

● 6738	BNC Female-to-Female-to-Female Adapter	02J8340	3.57	3.34
● 6739	BNC Female-to-Male-to-Female Adapter	02J8341	3.57	3.34
● 6754	BNC Female-to-Male-to-Female Adapter, In-Line	02J8351	3.57	3.34
● 6740	BNC Male-to-Male Adapter	02J8342	1.99	1.86
● 6737	BNC Female-to-Female Adapter	02J8339	2.52	2.35
● 6744	BNC Female-to-Female Panel Mount, Hermetically-Sealed Adapter	02J8344	3.12	2.91
● 6736	BNC Female Panel Receptacle, 0.50" Hole Spacing	02J8338	2.62	2.45
● 6735	BNC Male Panel Receptacle, 0.50" Hole Spacing	02J8337	3.12	2.91
● 6748	BNC Female PCB Mount, Right-Angle	02J8348	3.12	2.91
● 6747	BNC Female PCB Mount, Vertical	02J8347	2.62	2.45
● 6745	BNC Female Bulkhead Receptacle	02J8345	2.04	1.91
● 6741	BNC Female Bulkhead Receptacle, Isolated Ground	02J8343	2.52	2.35
● 4391-75	BNC Resistor Attenuator	10M4330	38.59	36.04

(90519)

ECO SERIES BNC COAXIAL CONNECTORS

Just Added



- Frequency range: DC to 1GHz
- Bayonet coupling
- Compliant to CECC and IEC standards
- Nickel-plated brass/die cast zinc connector body
- Gold-plated phosphor bronze female center contact
- PTFE / Polypropylene insulator

JACKS

Mfg. Part No.	Body Style	Impedance (Ω)	Connector Mounting	Coaxial Termination	RG/U	Stock No.	Price Each
							1-9
R141A306000	Straight Bulkhead	50	Cable	Crimp	174, 316	73P9190	1.46
R141A331500	Straight Bulkhead	50	Cable	Crimp	174, 316	73P9192	1.89
R141A332161	Straight Bulkhead	50	Cable	Crimp	58, 141	73P9194	1.52
R142A306500	Straight Bulkhead	75	Cable	Crimp	179, 187	73P9206	1.17
R142A325106	Straight Bulkhead	75	Cable	Crimp	BT3002	73P9208	2.09
R142A334161	Straight Bulkhead	75	Cable	Crimp	59, 62	73P9210	1.46
R141A605000	Straight Bulkhead	50	Panel	Solder	...	73P9196	1.67
R141A676121	Right Angle Bulkhead	50	PC Board	Solder	...	73P9198	2.19

PLUGS

R141A075161	Straight	50	Cable	Crimp	174, 316	73P9184	1.32
R141A082161	Straight	50	Cable	Crimp	58, 141	73P9186	1.22
R141A083000	Straight	50	Cable	Crimp	142, 223, 400	73P9188	1.17
R142A076161	Straight	75	Cable	Crimp	179, 187	73P9202	1.32

▶ CONTINUED ▶

RF COAX MINIATURE

ECO SERIES BNC COAXIAL CONNECTORS (CONT.)

PLUGS

Mfg. Part No.	Body Style	Impedance (Ω)	Connector Mounting	Coaxial Termination	RG/U	Stock No.	Price Each
R142A081177	Straight	75	Cable	Crimp	BT3002	11R6458	1.07
R142A085161	Straight	75	Cable	Crimp	59, 62	73P9204	1.26

75-OHM HDTV BNC COAXIAL CONNECTORS

Just Added



- Optimized electrical performance at 3 GHz, ideal for HDTV signal transmission
- Standard bayonet coupling system
- Intermateable with industry standard 50Ω and 75Ω BNC connectors
- 1000 mating cycles guaranteed
- Wide range of PCB and cable configurations
- Compatible with popular 75Ω HDTV coaxial cables

JACKS

Mfg. Part No.	Body Style	Connector Mounting	Coaxial Termination	Cable Group	Stock No.	Price Each		
						1-9	10-24	25-49
R142500730	Straight	PC Board	Solder	...	73P9224	3.16	2.93	2.71
R142568703	Straight	Card Edge	Solder	...	73P9226	2.79	2.59	2.39
R142334700	Straight Bulkhead	Cable	Crimp	0.8/3.7	73P9222	4.70	4.36	4.02

PLUGS

Mfg. Part No.	Body Style	Cable	Crimp	0.6/2.8	Stock No.	Price Each		
						1-9	10-24	25-49
R142077702	Straight	Cable	Crimp	0.6/2.8	73P9212	3.39	3.15	2.91
R142077712	Straight	Cable	Crimp	0.6/2.95	73P9214	3.39	3.15	2.91
R142077722	Straight	Cable	Crimp	0.8/3.7	73P9216	3.39	3.15	2.91
R142077732	Straight	Cable	Crimp	1.0/4.8	73P9218	3.56	3.31	3.05
R142187720	Right Angle	Cable	Crimp	0.8/3.7	73P9220	5.78	5.37	4.95

ADAPTERS

Mfg. Part No.	Body Style	Convert From	Convert To	Cable Group	Stock No.	Price Each		
						1-9	10-24	25-49
R142720700	Straight	BNC Jack	BNC Jack	...	73P9230	6.03	5.60	5.17
R142703703	Straight	BNC Plug	BNC Plug	...	73P9228	5.26	4.89	4.51

BOOTS

Mfg. Part No.	Cable Group	Color	Stock No.	Price Each		
				1-9	10-24	25-49
R280570000	0.6/2.8 - 0.6/2.95	Black	89C0166	0.46	0.42	0.39
R280571000	0.6/2.8 - 0.6/2.95	Red	12J2418	0.77	0.72	0.66
R280572000	0.6/2.8 - 0.6/2.95	Green	12J2419	0.77	0.72	0.66
R280573000	0.6/2.8 - 0.6/2.95	Blue	12J2420	0.77	0.72	0.66
R280574000	0.6/2.8 - 0.6/2.95	Yellow	12J2421	0.77	0.72	0.66
R280575000	0.6/2.8 - 0.6/2.95	Gray	12J2422	0.77	0.72	0.66
R280576000	0.6/2.8 - 0.6/2.95	White	12J2423	0.77	0.72	0.66
R280577000	0.6/2.8 - 0.6/2.95	Brown	12J2424	0.77	0.72	0.66
R280578000	0.6/2.8 - 0.6/2.95	Orange	12J2425	0.77	0.72	0.66
R280579000	0.6/2.8 - 0.6/2.95	Purple	12J2426	0.96	0.89	0.82
R280580000	0.6/2.8 - 0.6/2.95	Natural	10R2009	0.77	0.72	0.66
R280590000	0.8/3.7	Black	12J2427	0.77	0.72	0.66
R280591000	0.8/3.7	Red	12J2428	0.77	0.72	0.66
R280592000	0.8/3.7	Green	12J2429	0.77	0.72	0.66
R280593000	0.8/3.7	Blue	12J2430	0.77	0.72	0.66
R280594000	0.8/3.7	Yellow	12J2431	0.77	0.72	0.66
R280595000	0.8/3.7	Gray	12J2432	0.77	0.72	0.66
R280596000	0.8/3.7	White	12J2433	0.77	0.72	0.66
R280597000	0.8/3.7	Brown	12J2434	0.77	0.72	0.66
R280598000	0.8/3.7	Orange	12J2435	0.77	0.72	0.66
R280599000	0.8/3.7	Purple	10R2010	0.77	0.72	0.66
R280600000	0.8/3.7	Natural	12J2437	0.77	0.72	0.66

BNC CONNECTORS, 75-OHM DIGITAL

RoHS Compliant Available



- Voltage Rating: 500VACrms
- Operational Frequency: Up to 6GHz
- Dielectric Withstanding Voltage: 1500VACrms



UPL2000 Series

UPL2000 series high-frequency, true 75-ohm BNC crimp plugs are designed to handle high bit-rate digital video signal transmissions in conjunction with low-loss coaxial cable used in broadcast applications. Deliver long-term field performance at high frequency for error-free transmission of digital signals over the entire bandwidth utilized by HDTV

CONTINUED

BNC CONNECTORS, 75-OHM DIGITAL (CONT.)

signal transport. Fully enclosed, heat-treated beryllium copper outer conductor spring improves EM/RFI suppression and reduces signal loss. Black nickel-finished shell with machined PTFE insulator for superior RF electrical performance. Captivated and locking center contact plated with 50µ" gold over nickel over copper over brass. Gold-flash palladium, nickel-plated beryllium copper outer contact.

Mfg. Part No.	RG/U	Stock No.	Price Each
UPL2000-D1	Belden 1164B, 1167B, 1263A, 1406B, 1407B, 1417B, 1418B, 1855A, 1865A, 8218, 9170, CommScope 7536, 753603, 753604, 753605, 7538; GEPCO BSC809, VDFM809, VFM809, VSM618	88K2022	2.10
UPL2000-D2	Belden 1505A	88K2023	2.10
UPL2000-D4	Belden 1694A, 1828A, 1829A, 9114, 9248; CommScope 5765; GEPCO VSD2001	88K2025	2.10
UPL2000-D5	Belden 7731A; CommScope 5906	88K1283	7.22

VIDEO PATCH CORD

Mfg. Part No.	Length	Stock No.	Price Each
			1-9
PCW-36-75RED	36"	48F3811	27.50

75-OHM BNC BULKHEAD JACKS

RoHS Compliant Available



UCBJ20F Straight Flange



Bulkhead Jack



Launch the signal off the PC board in any direction through a bulkhead or motherboard. Reduce board space, cable bend and mating torque forces on the PC board. Mfg. part no. UBJJ27 insulated bulkhead jack features heat-treated beryllium-copper contact with 50µ" gold plating. Simple construction designed for fast and easy assembly. Close tolerances. Mfg. part no. UCBJ20F has a straight flange mount with 4 solder legs for torque support. Mfg. part no. UCBJFF20CP has a 45° flange mount with compliant pins for solderless installation and screw holes for mounting. Mfg. part no. UCBBJR229 has right-angle bulkhead mount with four legs and a "D" hole for torque and axial force. Mfg. part no. UCBEJ20-1 has a side-launch card edge mount. Solders to the card edge traces. Reduces space requirements between daughterboards. Designed with solder slots to reduce insertion and return loss compared to solder legs.

75-OHM JACKS AND RECEPTACLES

Mfg. Part No.	Description	Stock No.	Price Each	
			1-9	10-24
UBJ27	Front Mount, Solder Cup, 3.147" D. Hole	96B2669	10.79	8.86
UBJ28	Insulated, Feed-Thru	51B1357	13.67	11.23
BJ29-5	Rear Mount	96B8543	14.06	10.50
BJ48	50 Ohm Straight Bulkhead Jack, TNC	06C1688	18.61	15.30
BJ79-47	Straight Bulkhead Jack, TRB Feed through, max. panel thick 0.156"	92B5911	18.50	14.54
UCBJ224	Surface Mount BNC Jack	06C4378	3.80	3.47
UCBJ20F	Straight Flange Mount	96B2678	12.40	8.50
UCBBJE20-1	End Launch, Bulkhead Mount	22C4684	4.47	3.63
UCBJE20-1	Side-Launch Card Edge Mount	22C4690	4.77	3.94
UCBBJR229	Right-Angle Bulkhead Mount	19C6833	27.25	21.94

75-OHM BNC PLUGS

RoHS Compliant Available



BNC UPL220 Series



MBNC 250 Series

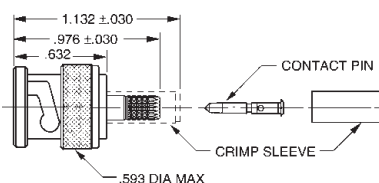

MBNC Cable Jack

Straight crimp plugs feature 50µ" gold-plated captive center contact pin. Spring-loaded coupling ring utilizes a beryllium-copper crescent washer. Full 0.50" machined crimp sleeve, 0.300" support ferrule with radial and axial grooves. NOTE: Mfg. part no. suffix (following dash) indicates cable group size.

Mfg. Part No.	For Cable RG/U	Stock No.	Price Each	
			1-9	10-24
UPL20-2	RG-59	06C4440	7.80	6.52
UPL220-004	RG-179, Belden 1520A and 1522A	48F2739	5.10	4.10

CONTINUED

75-OHM BNC PLUGS (CONT.)

Mfg. Part No.	For Cable RG/U	Stock No.	Price Each	
			1-9	10-24
● UPL220-009	Comm/Scope 0222, Belden 8218, Belden YR23023	48F2742	5.10	4.10
● UPL220-013	RG-59, RG-62	48F2743	5.10	4.10
● UPL220-017	RG-6	48F2749	5.10	4.10
● UPL220-025	AT&T 734, Comm/Scope 734###, Judd S95103101	48F2755	5.10	4.10
● UPL220-026	AT&T 735, Comm/Scope 735###, Judd S95103101	48F2756	5.10	4.10
● PL220-003	RG-174, 188, 316	06C3522	6.99	5.64

MINI BNC

Mfg. Part No.	Description	Stock No.	Price Each	
			1-24	25-99
● UPL250-026	Straight Coaxial Cable Plug, Lucent 735A Cable	33C2678	6.32	5.55
● UPL250-025	Straight Coaxial Cable Plug, Lucent 734A Cable	33C2677	6.32	5.55

(42271)

WRENCH-CRIMP BNC PLUGS



Mfg. Part No.	Ohms	For Cable RG/U	Stock No.	Price Each
● PL20-1	50	RG-58	50B8105	7.80
● PL20-2		RG-59	06C3507	7.80
● PL20-3		RG-223	50B8106	7.80
● PL20-5		RG-174	50B8107	7.80
● UPL20-5	75	RG-174	90B4196	7.80

(42270)

AMP TWIN BNC CONNECTORS



Designed in accordance with MIL-C-39012 to meet stringent requirements of MIL-STD-1553 multiplex data bus. Plating (center contact/body): silver/nickel for **mfg part nos. 332225-5** and **332342**. Accommodates twin conductor cable sizes, indicated below. Order hand tools separately on page 1039. See Manufacturer & Product Master Index for selection of coaxial cable.

Mfg. Part No.	Body Style	RG/U	Dielectric	Stock No.	Price Each		
					1-24	25-49	50-99
● 5332225-5	Plug	Belden 9272, 89272, 108, 108A	Polypropylene	16M3254	19.98	17.18	15.19
● 5332342	Bulkhead Jack	...	Teflon®	16M3255	29.70	25.55	22.58
● 5228686-1	Right-Angle PCB/ Panel Mount Jack	...	Polymethylpentene	42K8708	12.70	10.93	9.66

BULKHEAD ADAPTERS

Mfg. Part No.	Convert From	Convert To	Length (in.)	Stock No.	Price Each		
					1-24	25-49	50-99
● 5332215	BNC Jack	BNC Jack	1.406	73K1658	28.00	24.08	21.28

(8253)

MIL-C-39012 TWINAXIAL WEATHERPROOF COAXIAL CONNECTORS



Nonconstant impedance connectors for 78- and 95-ohm twin conductor cable. Improved shielding for use in balanced low level and high sensitivity circuits. 2 non-intermateable constructions available: BNC units (type numbers with prefix 31) are polarized contact design (1 male, 1 female), 2 stud bayonet coupling, captivated contacts, 0-100MHz, 100V peak voltage. Others polarized key/keyway construction, threaded coupling, 0-200MHz, 500V peak voltage.

➔ CONTINUED ➔

MIL-C-39012 TWINAXIAL WEATHERPROOF COAXIAL CONNECTORS (CONT.)

Mfg. Part No.	Fig.	RG/U	Description	Stock No.	Price Each
					1-9
● 82-5589*†	1	Brand Rex 2498 T8756A Belden 8227, 9207 IBM 7362211	Straight Plug/ IBM7362229	73K1487	47.02
● 531-40008*	Type F Straight Adapter	30C1286	10.64
● 31-2743-11	...	RG 307A	Straight Plug	30C1202	110.21
● 31-224	2	108A	Straight Plug	39F1468	8.82
● 31-2226	2	108A	Straight Plug	46F1168	17.06
● 82-5589-RFX1	...	Belden 8227, 9207	Keyed Plug	82K8902	7.09
● 31-223	3	...	Bulkhead Recept.	39F1470	19.37
● 31-2225	3	...	Bulkhead Recept.	51F3819	17.24

*Twinaxial Keyed 90°; †For use with **mfg. part no. 227-1417** die set and **mfg. part no. 227-987** tool handle; order tool handle separately on page 1039 or **mfg. part no. 227-1414** die set and **mfg. part no. 227-944** tool handle; order tool handle separately on page 1040.

BETWEEN-SERIES ADAPTERS

Mfg. Part No.	Description	Stock No.	Price Each
			1-9
● 31-28	BNC Jack-to-UHF Plug	39F074	19.75
● 79675	BNC Jack-to-TNC Plug	59K0522	28.81
● 79025	BNC Plug-to-TNC Jack	39F1083	38.69
● 2900	BNC Plug-to-UHF Jack	73K1423	20.40
● 901-164	BNC Plug to SMA Plug	59K0540	88.38
● 82-5558	BNC Socket to Type N Pin Adapter	83C5680	21.94
● 31-216	BNC Jack-to-N Plug	39F1029	11.59
● 78800	N Plug-to-TNC Jack	73K1482	29.17
● 31-217	BNC Plug-to-N Jack	39F1030	15.32
● 901-295	SMA Jack-to-N Jack	90F8462	162.26
● 901-9720	SMA Jack-to-N Jack	93F1355	73.31
● 79825	N Jack-to-TNC Plug	55M2571	43.43
● 16075	HN Jack-to-N Plug	50F1612	86.69
● 16050	HN Plug-to-N Jack	73K1394	47.62
● 4400 UG 146 U	UHF Jack-to-N Plug	73K1463	16.86
● 901-293	SMA Plug-to-N Jack	51F3790	100.60
● 901-166	SMA Plug-to-BNC Jack	98F2748	64.69
● 901-165	SMA Jack-to-BNC Plug	98F2747	54.74
● 901-167	SMA Jack-to-BNC Jack	51F3813	43.64
● 901-294	SMA Jack-to-N Plug	90F8461	117.17
● 901-9034	SMA Jack-to-SMB Plug	93F1308	80.08
● 901-9033	SMA Jack-to-SMB Jack	93F1307	118.17
● 901-280	SMA Jack-to-TNC Jack, 4-hole Flange Mount	99F3887	115.75
● APH-716M-NF	716 Plug-to-Jack Interface per MIL-STD-348	59K0103	65.26

TRIAX WEATHERPROOF TRANSMISSION LINE COAXIAL

For maximum RF shielding, minimum noise radiation; in triaxial cable where shielding better than 30dB. Non-constant impedance; accept 75-ohm cable where impedance mismatch not critical.

Mfg. Part No.	Fig.	RG/U	Description	Thread	Stock No.	Price Each
						1-9
● 34475	Bulkhead Receptacle	7/8-20	73K1452	102.25
● 53175	...	RG 11, Belden 1859, 7731, 8213, 9292	Straight Plug	7/8-20	39F3337	205.37
● 53150	...	RG 58, 58A, 58C, 141, 303, LMR 195, Belden 7806A	Straight Plug	7/8-20	73K1470	86.60

(8200)

RFX™ KEYED 90° TWINAX CONNECTORS



Used principally in system 3X/400 applications for balanced line high sensitivity circuits. Normally used on 100-ohm twinaxial cable. DC-200MHz with voltage rating of 500V peak. 3/4-20 thread.

Mfg. Part No.	Fig.	Description	Stock No.	Price Each			
				1-9	10-24	25-99	100-499
● 82-5588-RFX	1	Barrel Adapter, Jack-Jack	93F1457	7.94	7.25	6.68	6.19
● 82-5589-RFX	2	Cables to IBM ref. 7362211, Plug	93F1458	6.13	5.61	4.92	4.66
● 82-5590-RFX	3	Front Mount Receptacle	93F1459	10.69	9.71	8.90	8.23

(8272)

RF COAX MINIATURE

TRIAx CONNECTORS



Small, lightweight, weatherproof miniature connectors are manufactured to MIL-PRF-39012 requirements and are typically used in applications operating up to 4 GHz. BNC connectors are used in data networking as well as video, audio and test equipment application. Video applications such as security systems use 75 versions to match the standard system impedance.

Mfg. Part No.	Body Style	Description	Body Style	Stock No.	Price Each
				1-24	25-49
73415-1710	Straight Plug	High Voltage, Clamp, 3-slot	0.140" Triax	44K0021	28.19
73415-4530	Right Angle Jack	3-Lug, PCB	...	32M0823	55.45
73175-0000	Straight Plug	Termination:Solder	...	32M0763	19.18
73175-0020	Straight Plug	Termination:Crimp	...	32M0764	21.39
73175-0050	Straight Plug	Termination:Crimp	...	32M0765	20.67

(90514)

TWINAXIAL CONNECTORS AND PHONO ADAPTERS



Pomona twinaxial connectors and adapters feature bodies with tarnish resistant nickel plated brass.

TWINAXIAL CONNECTORS

Mfg. Part No.	Description	Stock No.	Price Each	
			1-24	25-49
4957	BNC Male Twinaxial Plug to Cable, RG-108U, -108A/U, Belden 9272	44F8848	29.10	27.85
4958	Twinaxial BNC Bulkhead Receptacle	44F8844	11.66	11.16

PHONO ADAPTERS

Mfg. Part No.	Description	Stock No.	Price Each	
			1-24	25-49
5319	BNC Female to Phono Plug Adapter	46F2379	7.15	6.78
4054	BNC Male to 1/4" Audio Phono Jack	44F5329	19.40	18.40
1297	BNC Female to Standard 1/4" Two Conductor Phone Plug	10M4164	13.34	12.65

(90525)

TRIAxIAL, PANEL MOUNT, AND BULKHEAD CONNECTORS

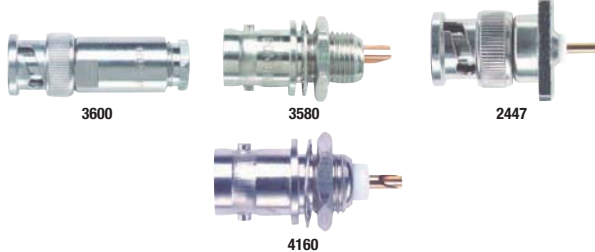

TRIAxIAL CONNECTORS AND ADAPTERS

Pomona triaxial, panel mount, and bulkhead connectors feature bodies with tarnish resistant nickel plated brass.

Mfg. Part No.	Description	Stock No.	Price Each	
			1-24	25-49
3600	Triaxial Cable 2 Lug Male	44F5331	54.68	51.93
3580	Triaxial Bulkhead 2 Lug Female	44F5327	45.08	42.81
5219	Triaxial 3 Lug Bayonet BNC Style Female Bulkhead Mount	87F026	19.96	18.96
5056	Triaxial 2 Lug Male Connector to Cable	44F8849	27.03	25.67
5218	Triaxial 3 Lug Male Connector to Cable	87F022	36.05	34.24
5290	Triaxial 2 Lug Female-to-Female Adapter	46F2375	33.39	31.71
5298	Triaxial 2 Lug Female-to-BNC Male Adapter	46F2377	33.07	31.40
5299	Triaxial 3 Lug Female-to-BNC Male Adapter	46F2378	6.72	6.38
5300	BNC Female-to-Triaxial 3 Lug Male Adapter	46F4502	35.32	33.55

PANEL MOUNT AND BULKHEAD CONNECTORS, 50Ω

2447	BNC Male Panel Mount Connector	30F1432	10.94	10.39
2451	BNC Female Panel Mount Receptacle	39F3634	6.41	6.09
4979	BNC Male Bulkhead Receptacle	89F370	8.56	8.13
4160	BNC Female Bulkhead Connector	39F3628	2.81	2.67
4159	BNC Female Bulkhead Receptacle, Hermetically-Sealed	77B2456	20.64	19.61
3778	BNC Female Bulkhead Receptacle, Isolated Ground	30F1403	3.37	3.20
5148	BNC Female Bulkhead Receptacle, Isolated Ground*	89F362	6.09	5.78

* Valox Insulation (12741)

TWINAX/TRIAx CONNECTORS

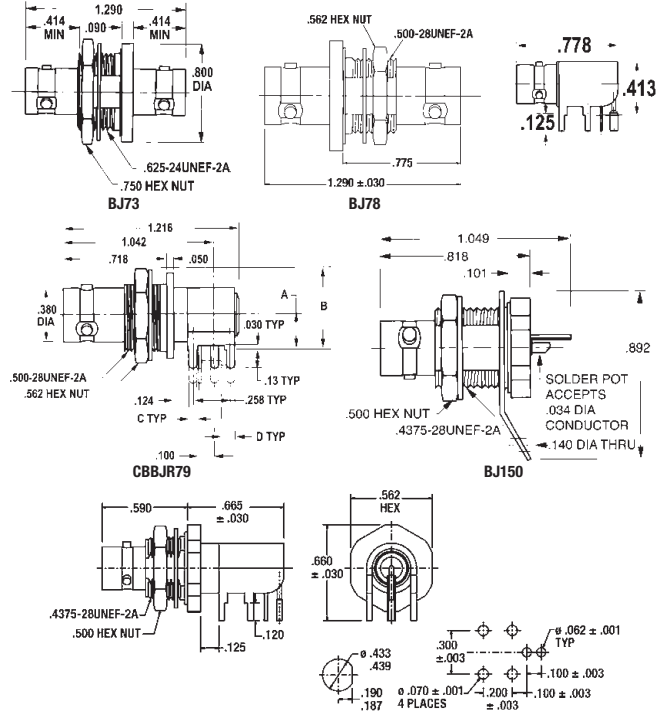

70 series twinaxial/triaxial connectors are concentrically designed with 2 concentric contacts isolated from each other, the center contact, and the shielding connection. They are used in digital data bus, MIL-STD-1553B (airborne/ground, primary/redundant) base-band circuits, and video pair applications (FLIR). Field serviceable wrench crimp version for quick termination of cables up to 0.250" diameter. Tool crimp version requires hand tools for assembly ("C" in type number). Digits in type number following dash indicate cable/group size. Connectors do not require mechanical alignment for mating. Nominal impedance non-constant. Frequency range: 0-500MHz. Voltage rating: 400V (100V @ 70,000), Insulation resistance: 5000MΩ. Temperature range: -65° to +165°C. Cable retention force (min.) 40 lbs. with 0.200-0.325" O.D. cable. 150 series connectors have the same electrical characteristics but are smaller in size.

70 SERIES CABLE PLUGS

Mfg. Part No.	Description	For Cable	Stock No.	Price Each	
				1-24	25-99
PL74-9	2 Lug, Wrench Crimp, Twinax	Trompeter TWC-78-2	91B8642	21.12	16.37
PL74-7	2 Lug, Wrench Crimp, Triax	M17/134-00001, TRC-50-2	91B1955	21.12	16.37
PL75-29	3 Lug, Wrench Crimp, Twinax	M2750022TN2N06, TWC-124-1A	48F2787	21.12	16.37
PL75-9	3 Lug, Wrench Crimp, Twinax	Trompeter TWC-78-2	48F2790	21.12	16.37
PL75-7	3 Lug, Wrench Crimp, Triax	Trompeter TRC-50-2	48F2789	21.12	16.37
PL75-47	Wire Crimp, Push On	M17/176-00002	48F2788	21.12	16.37
PL75C-201	3 Lug, Tool Crimp	M17/176-00002	48F2791	21.76	17.11
PL75C-204	3 Lug, Tool Crimp	Raychem 10602	48F2786	21.76	17.11
TNG1-1-78	Terminator, TRB Plug, 78Ω	...	50B8126	29.20	24.37
PL375-13A	Threaded, Wrench Crimp, Triax Plug	Belden 8232	94B3176	62.71	47.36
PL375-7	Threaded, Wrench Crimp, Triax Plug	TRC-50-2, 75-2	50B8114	18.71	14.51
PL74-47	2-Lug, Wrench Crimp, Triax Plug	M17/175-00002	91B3220	21.12	16.37
PL75-45	2-Lug, Wrench Crimp, Triax Plug	M27500-22TE2E141100-66F	50B8117	21.12	16.37
PL80-7	2-Lug, Wrench Crimp, Twinax/Triax Plug	TRC-50-2, 75-2	51B1347	63.35	48.87
PLR75C-201	3-Lug, Right-Angle, Tool Crimp TRB Plug	M17/176-00002	48F2797	143.59	104.97
PLR155AC-201	3-Lug, Right-Angle, Tool Crimp TRS Plug	M17/176-00002	48F2792	209.66	140.54
HP437	0.437" Hole Plug for Jack and Panel	...	06C2799	0.29	0.25

CONTINUED

TWINAX/TRIAX CONNECTORS (CONT.)

BULKHEAD BNC AND TRC JACKS

Mfg. Part No.	Description	Stock No.	Price Each	
			1-9	10-24
● BJ21	Insulated, Rear Mount Solder	90B5861	12.45	9.57
● BJ27	Insulated, Front Mount Solder	90B9531	10.84	8.49
● BJ28	Insulated, Feed-Thru	92B1854	11.66	9.59
● BJ72	3-Lug, Insulated, Front Mount	48F2772	23.90	20.50
● BJ73	3-Lug, Insulated, Feed-Thru	48F2773	26.81	21.09
● BJ74-47	Insulated, Rear Mount Wrench Crimp	92B6151	22.69	17.83
● BJ75	3-Lug, Insulated, Rear Mount, Solder Pot	48F2774	25.86	22.61
● BJ76	3-Lug, Rear Mount, Solder Pot	48F2775	22.17	17.16
● BJ77	3-Lug, Front Mount, Solder Pot	48F2776	17.50	13.10
● BJ78	3-Lug, Feed-Thru	48F2778	19.16	13.94
● BJ88	TRC, Feed-Thru	92B4873	49.81	42.71
● BJ770	3-Lug, Front Mount, Solder Pot	48F2777	17.50	13.10
● CJ70-7	TRC 3-Lug, Wrench Crimp Cable Jack	51B1341	16.98	13.35
● CJ70-9	TWC 3-Lug, Wrench Crimp Cable Jack	93B9017	16.98	13.35
● CJ70-29	TWC 3-Lug, Wrench Crimp Cable Jack	92B7777	16.98	13.35
● CJ70-47	M17 3-Lug, Wrench Crimp Cable Jack	96B7932	16.98	13.35

150 SERIES CABLE PLUGS

Mfg. Part No.	Description	Stock No.	Price Each	
			1-9	10-24
● PL155-29	3-Lug, Wrench Crimp Cable Plug, Twinax	96B5742	16.68	13.44
● PL155-47	3-Lug, Wrench Crimp Cable Plug, Twinax	92B3418	16.68	13.44
● PL155AC-201	3-Lug, Tool Crimp Cable Plug, Twinax	48F2784	23.04	18.12

150 SERIES BULKHEAD PC BOARD JACKS

Mfg. Part No.	Description	Stock No.	Price Each	
			1-9	10-24
● BJ150	3 Lug, Rear Mount, Solder Pot	48F2770	22.22	17.46
● BJ157	3 Lug, Front Mount, Solder Pot	48F2771	14.60	11.69
● CBJ157	3 Lug, PC Board	48F2781	35.05	27.42
● CBJR157	3 Lug, Right-Angle PC Board	48F2782	49.42	37.59
● CBBJR26	Insulated, Right-Angle, PC Board	90B3904	32.65	26.29
● CBBJR79	3-Lug, Right-Angle, PC Board, Standard	48F2780	49.32	37.90
● CBJ70	3-Lug, Straight, PC Board, Standard	91B5695	49.49	38.42
● BJ158	3-Lug, Insulated Feed-Thru	96B5790	27.31	21.99
● CBBJ79	3-Lug, Non-insulated Twinax/Triax Bulkhead Jack	48F2779	41.89	34.39
● CBBJR79A	TRB Right-Angle, Bulkhead	06C1863	49.32	37.90
● CBJR-70	TRB Right-Angle, PC Board	91B8457	86.59	67.77
● AD78	TRB Within Series Adapter	91B5771	17.58	13.82

ADAPTERS

● ADBJ20-E1-PL75	Female BNC to Male TNC	51B1333	45.58	36.83
● ADBJ20-E1-BJ79	70 Series U/BJ20/ 40	90B5852	61.46	49.65
● ADBJ20-E2-PL75	Female BNC/TNC to Male	97B4161	55.87	45.14
● BN73	TEE Adapter 3-Lug	91B3440	57.77	46.28

(41978)

50- AND 75-OHM ZDC SERIES TNC CONNECTORS

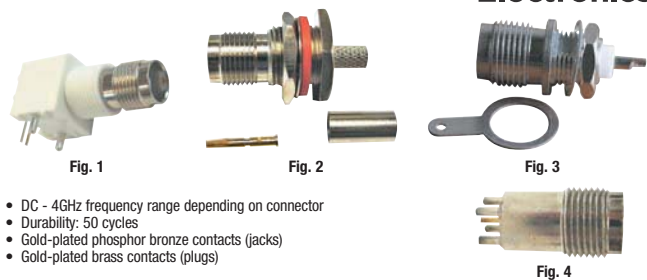

- DC - 4GHz frequency range depending on connector
- Durability: 50 cycles
- Gold-plated phosphor bronze contacts (jacks)
- Gold-plated brass contacts (plugs)

RIGHT ANGLE JACK

Mfg. Part No.	Fig.	Impedance (Ohms)	RG/U	Coaxial Termination	Connector Mounting	Stock No.	Price Each	
							1-9	1-49
● 5-1814807-1	1	50	...	Solder	PC Board	78M7252	3.26	

STRAIGHT BULKHEAD JACK

● 5-1814802-3	2	50	58, 141	Crimp	Cable	78M7248	3.76	
● 5-1814804-1	3	50	...	Solder	Bulkhead	78M7249	1.93	
● 5-1814804-3	3	75	...	Solder	Bulkhead	78M7250	2.17	

STRAIGHT JACK

● 5-1814805-1	4	50	59	Solder	PC Board	78M7251	2.73	
---------------	---	----	----	--------	----------	---------	------	--

▶ CONTINUED ▶

50- AND 75-OHM ZDC SERIES TNC CONNECTORS (CONT.)

STRAIGHT PLUG

Mfg. Part No.	Fig.	Impedance (Ohms)	RG/U	Coaxial Termination	Connector Mounting	Stock No.	Price Each	
							1-9	1-49
● 5-1814800-3	...	50	58, 141	Crimp	Cable	78M7246	2.04	
● 5-1814801-3	...	75	59, 62, 140, 210	Crimp	Cable	78M7247	2.25	

(108538)

AMP 50-OHM AND 75-OHM TNC CONNECTORS



Dual crimp connectors manufactured in accordance with MIL-C-39012, Class II, Category B. Order hand tools separately on page 1039.

50-OHM PC BOARD/PANEL MOUNT TNC JACKS

Mfg. Part No.	Description	Dim. L	Stock No.	Price Each	
				1-9	10-24
● 5227818-1	Right-Angle PC Board/Panel Mount Jacks Posts	0.835"	16M3246	9.74	9.04
● 5227839-1	Right Angle Jack/PC Board	0.820"	17M9560	7.35	6.95

50-OHM BULKHEAD SOLDER TNC JACK AND JACK ADAPTER

Mfg. Part No.	Description	Dim. L	Stock No.	Price Each	
				1-9	10-24
● 5227839-1	Bulkhead Solder Jacks With Solder Terminals	1.375"	17M9560	7.35	6.95

50-OHM BULKHEAD SOLDER TNC JACK AND JACK ADAPTER

Mfg. Part No.	Description	Dim. L	Stock No.	Price Each	
				1-24	25-49
● 221500-1	Bulkhead Adapter	1.58"	89F2939	12.13	10.42
● 5414168-3	Bulkhead Adapter	1.375"	16M3268	7.96	7.39

50-OHM TNC PLUGS

Mfg. Part No.	RG/U	Crimp Type	Length	Stock No.	Price Each	
					1-9	10-24
● 5222506-5	174, 188, 188A, 316	Hex	1.230"	16M3217	5.28	4.74
● 5222506-1	58, 58A, 58B, 58C	Hex	1.230"	57K6380	8.28	7.56
● 1-5225550-2		Dual	1.375"	16M2666	46.71	43.36
● 5225555-2		Dual	1.375"	16M3231	21.10	18.15
● 5225559-2		Dual	1.835"	16M3233	29.90	26.91
● 225550-1	223, 55, 55A, 55B	Dual	1.375"	89F2934	32.38	27.85
● 5-225345-6	142, 142A, 142B, 400	Dual	1.343"	16M3161	36.13	33.54
● 4-5227000-6	142, 142A, 142B, 400	Dual	1.055"	16M3039	3.83	3.55
● 5225555-6	142, 142A, 142B, 400	Dual	1.375"	42K8690	15.72	14.15
● 5221506-2	Beld. 8281, 9141, 9231	...	1.295"	10M9832	6.84	6.35
● 1057631-1	402/U	...	0.770"	10H7245	22.67	21.54
● 225345-6	142, 142A, 142B, 400	Dual	1.343"	89F2906	34.38	31.89
● 225554-6*	142, 142A, 142B	Dual	2.5"	90B4658	40.05	36.73
● 5225554-6*	142, 142A, 142B	Dual	2.5"	42K7119	35.01	31.51

▶ CONTINUED ▶

RF COAX MINIATURE

AMP 50-OHM AND 75-OHM TNC CONNECTORS (CONT.)

50-OHM TNC JACKS

Mfg. Part No.	RG/U	Crimp Type	Length	Stock No.	Price Each	
					1-9	10-24
225551-2	58, 58A, 58B, 58C	Dual	1.406"	96F7800	41.44	38.47
225551-6	142, 142A, 142B, 400	Dual	1.406"	96F7801	36.94	33.43
● 5225557-6	...	Dual	1.500"	16M3232	48.47	44.99
● 3106 7941 00†	402/U	...	0.642"	07H8313	60.80	56.44

*Right Angle; †Solder (8242)

50-OHM MINIATURE THREADED WEATHERPROOF TNC COAXIAL CONNECTORS



Amphenol® RF
Global RF Solutions

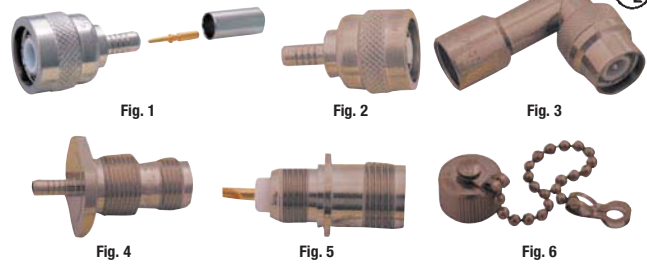

- Impedance: 50Ω
- Frequency range: 0-11GHz

TNC are miniature, threaded weatherproof units with a constant 50 Ω impedance and they operate from 0 - 11 GHz. Ideal for use in cellular and mobile communications, and test and measurement equipment. Also used in airframe, aerospace and radar applications where extreme vibration is a factor. Reverse polarity is a keying system accomplished with a reversed interface which ensures that a reverse polarity TNC does not mate with a standard TNC connector. May be used in applications where keying is necessary to eliminate mis-matching from mating with a standard connector. MIL-STD-348 interface ensures high quality and premium performance. Crimp-crimp termination allows easy and quick assembly. *Order tools and die sets separately, go online or call.*

STRAIGHT PLUGS

Mfg. Part No.	Fig.	Termination	RG/U	Stock No.	Price Each 1-9
● 36825	1	Crimp	58, 141	50F2467	5.21
● 31-2367	1	Crimp	58, 141	40F6332	5.28
● 31-2368	1	Crimp	59, 62	51F3798	5.40
● 31-2373	1	Crimp	142, 223	40F6331	4.91
● 31-4452	1	Crimp	142, 400	19C3304	9.77
● 31-2315	1	Crimp	174, 188	73K1430	5.94
● 31-5677	2	Crimp	58, 58A, 58C, 141, 303, LMR195	50B791	6.83
● 31-5061	...	Crimp	59, 62, 140, 210	59K0376	71.78
● 79875	...	Clamp/Solder	55, 58, 141, 142, 223, 400	77B6498	33.96

RIGHT-ANGLE PLUG

● 79075	3	Clamp	55, 58, 141, 142, 223, 400	51F3800	100.05
● 31-2381	...	Crimp/Crimp	58, 142, 223, 400	19C3274	15.75

STRAIGHT BULKHEAD JACKS

● 31-2389	4	Crimp	58, 141	98F625	23.39
● 31-2318	4	Crimp	174, 188, 316	77B6687	10.44

FRONT MOUNT STRAIGHT BULKHEAD JACK

● 31-2301	5	Solder	174, 188, 316 Isolated	40F6335	6.25
-----------	---	--------	------------------------	-------------------------	------

STRAIGHT 4-HOLE FLANGE MOUNT JACK

● 31-2300	40F6334	8.14
-----------	-----	-----	-----	-------------------------	------

REVERSE POLARITY STRAIGHT PLUGS

● 31-5677-1000	...	Crimp	55, 142, 223, 400	29C7030	9.67
● 31-5679	...	Crimp	LMR400, Belden 7810A, 8214, 9913	92B7474	10.32

REVERSE POLARITY STRAIGHT JACKS

● 31-5678	...	Crimp	58, 58A, 58C, 141, 303, LMR195	27C3702	14.40
● 31-5684	...	Crimp	LMR400, Belden 7810A, 8214, 9913	92B7473	9.32

REVERSE POLARITY STRAIGHT BULKHEAD JACKS

● 31-5686	...	Crimp	178, 196, .071" Outer Diameter	96B1144	10.56
● 31-5687	...	Crimp	58, 58A, 58C, 141, 303, LMR195	50B792	12.63

REVERSE POLARITY RIGHT-ANGLE PC BOARD JACK

● 31-5688	30C1251	18.68
-----------	-----	-----	-----	-------------------------	-------

IN-SERIES ADAPTERS

Mfg. Part No.	Fig.	Description	Stock No.	Price Each 1-9
● 79100	...	Bulkhead Jack-to-Bulkhead Jack, Straight	59K0521	57.20
● 79125	...	Jack-to-Plug, Right Angle	77B6490	37.29
● 31-4804	...	Jack-to-Bulkhead Jack, Straight	81F733	14.44

▶ CONTINUED ▶

50-OHM MINIATURE THREADED WEATHERPROOF TNC COAXIAL CONNECTORS (CONT.)

ACCESSORY

Mfg. Part No.	Fig.	Description	Stock No.	Price Each 1-9
● 78750	6	Male Cap	73K1481	8.92

50-OHM RFX™ TNC CONNECTORS



Amphenol® RF
Global RF Solutions



- Impedance: 50Ω
- Frequency range: 0-11GHz
- RFX suffix denotes commercial grade

Order tools and die sets separately on pages 1039-1040.

STRAIGHT PLUGS

Mfg. Part No.	Fig.	Cable Termination	RG Cable Type	Stock No.	Price Each			
					1-9	10-24	25-99	100-499
● 31-2367-RFX	1	Crimp	58, 141	93F1427	1.54	1.40	1.29	1.18
● 31-6001-RFX	...	Crimp	LMR400, Belden 7810A, 8214, 9913	95B8146	7.16	6.51	5.97	5.51
● 79875-RFX	...	Clamp/Solder	58, 142A	93F1397	2.65	2.42	2.01	1.88
● 31-2315-RFX	...	Crimp	174, 188A, 316, Belden 7805A	93F1426	1.87	1.70	1.56	1.44

STRAIGHT JACK

● 31-2374-RFX	2	Crimp	58, 141	19C3272	2.17	1.98	1.83	1.70
---------------	---	-------	---------	-------------------------	------	------	------	------

STRAIGHT BULKHEAD JACKS

● 31-2318-RFX	3	Crimp	174, 188A, 316, Belden 7805A	19C3269	2.65	2.41	2.21	2.03
● 31-2389-RFX	3	Crimp	58, 58A, 58C, 141, 303, LMR195	96B4551	3.78	3.45	3.18	2.95

(8217)

V-BITE® PC EDGE MOUNT TNC COAXIAL CONNECTORS



BOMAR
INTERCONNECT PRODUCTS, INC.

- Low profile, 0.270" high FMS
- Anti-rotational
- VSWR 1.15:1
- Patented V-Bite® snaps into PC board
- Surface mount center contact
- TFE insulator

Just Added

TNC TYPE EDGE MOUNT JACK

Mfg. Part No.	Impedance (Ω)	Contact Material	Contact Plating	Features	Stock No.	Price Each 1-24	25-49
● 561V504EFT	50	Phosphor Bronze	Gold	Flanged	80K0442	6.82	6.17

(14225)

50-OHM TNC STYLE STRAIGHT RF COAXIAL PLUGS



KINGS
by WINCHESTER ELECTRONICS



- Frequency range: 0 - 11GHz
- Size: 1.08L x 0.63"W

TNCs are weatherproof. Its threaded coupling ensures low noise as well as the ability to withstand shock and vibration. Applications: airframe, missile, radar and precision electronic equipment industries.

Mfg. Part No.	Mil. No. M39012/	Contacts	For RG/U Cable	Stock No.	Price Each 1-499
● KA-59-22	26-0101	Captive	58", 58A", 58C, 141, 141A, 55A, 142, 142A, 223, 499	90F3269	14.68
● KA-59-230	26-0011	Crimp and Captive	55A, 142, 142A, 223, 400	90F3270	10.30
● KA-59-287	26-0504	Crimp and Captive	58", 58A", 58C, 141, 141A, 55A, 142, 142A, 223, 499	90F3274	11.82

*Crimping the center contact is not recommended when crimp contact is indicated (8864)

VOLTREX® BRAND TNC CONNECTORS



50Ω TNC CONNECTORS AND ADAPTERS

Just Added

Pomona®



Fig. 1



Fig. 2



Fig. 3



Fig. 4



Fig. 5



Fig. 6



Fig. 7

TNC plugs and jacks have a voltage rating of 500 V RMS and a frequency rating of 0-4GHz, except mfg. part nos. SPC19882 and SPC19883, which have a frequency rating of 0-11GHz. Feature Delrin insulation except mfg. part nos. 1536, 1540, SPC19882 and SPC19883 which are Teflon®. Mfg. part nos. with (*) have brass contacts; (+) gold; (†) silver. Order mfg. part no. CTR-8556-01 crimp tool separately; go online or call.

75-OHM TNC PLUGS

Mfg. Part No.	Fig.	RG/U	Jacket O.D.	Stock No.	Price Each	
					1-99	100-249
● CPMC-TNC-59/62*	1	59, 62	0.220-0.250"	90N3208	3.26	2.60
● 1544+ ++	1	59	0.220-0.250"	92N3390	4.48	3.67

50-OHM TNC CRIMP JACKS

● SPC4347+	2	58	0.195-0.210"	84N1271	7.37	6.05
------------	---	----	--------------	---------	------	------

TNC CRIMP PLUGS

● 1539+	1	8	0.395-0.415"	92N3385	5.83	4.78
● SPC19883†‡	1	8X	...	83K0858	3.11	2.48
● MC23545	1	58	...	96M8829	1.39	1.25
● 1536†‡	4	58	0.195-0.210"	92N3382	7.13	5.85
● 1537+	1	58	0.195-0.210"	92N3383	4.44	3.65
● SPC19882†‡	1	142	...	83K0857	5.61	4.48
● MC23565	1	142	...	96M8849	2.26	1.85
● MC23584	...	174	...	96M8868	1.68	1.52
● MC23583	4	Belden 9913	...	96M8867	3.00	2.46

TNC CRIMP PLUGS - REVERSE POLARITY

● SPC10036†‡	1	58	...	18C1909	5.54	4.55
● SPC10038†‡	1	174	...	18C1911	5.54	4.55
● SPC10037†‡	1	Belden 9913	...	18C1910	9.28	8.48

TNC CRIMP JACKS - REVERSE POLARITY

● SPC10044†‡	2	58	...	18C1917	5.40	4.43
● SPC10047†‡	2	Belden 9913	...	18C1920	4.48	3.68

TNC BULKHEAD JACKS

● 1540+	3	92N3386	5.91	4.85
● 1541+ **	5	58	0.195-0.210"	92N3387	8.44	6.92
● MC23581	5	174	...	96M8865	4.15	3.41

TNC BULKHEAD CRIMP JACKS - REVERSE POLARITY

● SPC10040†‡	5	18C1913	4.22	3.46
--------------	---	-----	-----	---------	------	------

50-OHM TNC TWIST-ON PLUGS

● 1545†	6	58	0.195-0.210"	92N3391	5.06	4.15
---------	---	----	--------------	---------	------	------

50-OHM TNC TERMINATORS

CP-TNC-T-50	7	...	0.315"	90N3215	4.01	3.19
-------------	---	-----	--------	---------	------	------

†Solder; **Rear-Mount Crimp; +75 Ohm (18027)

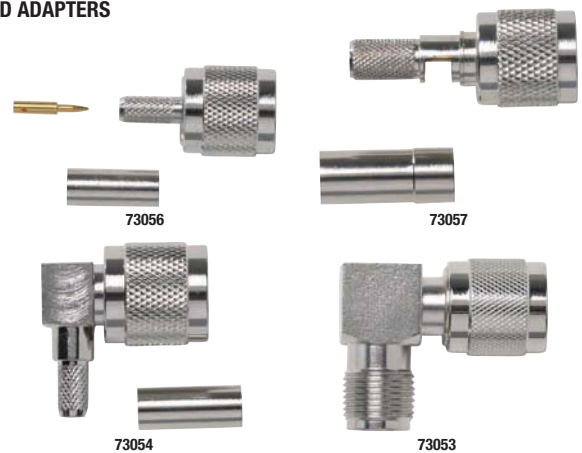

- Plugs have gold-plated brass contacts
- Jacks have gold-plated phosphor bronze contacts

STRAIGHT PLUGS

Mfg. Part No.	Connector Mounting	Coaxial Termination	RG/U	Stock No.	Price Each
					Each
73056	Cable	Crimp	58, 141	08R6360	5.87
73057	Cable	Crimp	59, 62	08R6361	6.00

RIGHT ANGLE PLUGS

73054	Cable	Crimp	55, 142, 223, 400	08R6359	6.66
-------	-------	-------	-------------------	---------	------

ADAPTERS

Mfg. Part No.	Body Style	Convert From	Convert To	Stock No.	Price Each
					Each
73053	Right Angle	TNC Jack	TNC Plug	08R6358	11.07

(147912)

WEATHERPROOF MINIATURE 5-AMP MHV COAXIAL CONNECTORS



Fig. 1



Fig. 2



Fig. 3



Fig. 4



Fig. 5



Fig. 6

Bayonet-lock coupling units for voltage applications to 5000V peak at frequencies 50MHz. All are nonconstant impedance, with male contacts and TFE insulation. Temperature range: -65°C to +165°C. Mfg. part nos. 27000 and 27025 receptacles rear mount units. Meet MIL-C-39012. Order tools and die sets separately on page 1039.

Mfg. Part No.	Fig.	MIL No.	RG/U	Description	Stock No.	Price Each
						1-9
● 28000	1	UG-932	59, 62, 71, 140, 210	Straight Plug	39F1322	11.96
● 29100	1	...	55, 58, 141, 142	Straight Plug	39F3334	12.02
● 27975	1	UG-932A	59, 62, 71, 140, 210	Straight Cable Plug	73K1421	44.90
● 27000	2	UG-931	...	Panel Recept.	73K1420	10.97
● 27025	3	Bulkhead Recept.	39F3335	30.19
● 10400	3	Bulkhead Recept.	51F3814	43.69
● 28100	4	...	59, 62, 71, 140, 210	Angle Plug	51F3815	32.96
● 27075	5	UG-1016A/U	59, 62, 71, 140, 210	Straight Jack	51F3816	29.01
● 28175	6	UG-961A/U	59, 62, 140, 210	Panel Jack	73K1422	91.88
● 12650	Adapter (Jack-Jack)	51F3817	75.41

(8248)

Current Order Status & History

Check the status of your current order or access past orders from our website under MY ACCOUNT eSuite. Log in or register today.



Make it easy. Make it fast. Make it Newark.

(148883)

RF COAX MINIATURE • RF COAX SUBMINIATURE

AMP SHV CONNECTORS



51494-4



51494-2

- Voltage: 350V
- Current: 3A
- Operating Temperature: -65° to +200°C

Comply with National Bureau of Standards' specifications ND-545 and meet all specifications of the Nuclear Regulatory Commission for NIM standard, high-voltage connectors. Teflon® dielectric. Meet military specification MIL-G-45204. Order hand tools separately, go online or call.

DUAL CRIMP SHV PLUGS

Mfg. Part No.	RG/U	Coaxial Termination	Plating: Center Contact/Body	Dim. L	Stock No.	Price Each	
						1-24	50-99
51426-1	58, 58A, 58B, 58C	Crimp	Gold/Nickel	1.452"	85C1645	51.63	
9-51426-1	58, 58A, 58B, 58C	Crimp	Gold/Nickel	1.452"	42K7941	34.54	
5051426-2	124, 140, 210, 62, 62A/B, 59, 59A/B, Belden 9291, 9209, 9268	Crimp	Gold/Silver	1.45"	42K6956	41.91	
5051426-4	58, 58A, 58B, 58C	Crimp	Gold	1.437"	16M3980	33.78	
5051426-5	59, 59A/B, 62, 62A/B, 124, 140, 210, Belden 9209, Belden 9269, Belden 9291	Crimp	Gold	1.452"	42K6957	39.11	

BULKHEAD SHV JACK

5051494-1	...	Solder	Gold/Nickel	1.857"	42K6958	27.20	
51494-2	...	Solder	Gold/Nickel	1.857"	89F3394	17.23	
225059-3	9, 59A, 59B, 62, 62A, 62B, 124, 140, 210	Crimp	Gold/Nickel	...	89F3383	49.22	

(8240)

SHV/MHV/10KV/20KV HIGH VOLTAGE RF COAXIAL PLUGS



1705-14



1705-1, 1705-2

SHV STYLE RF COAXIAL STRAIGHT PLUGS

SHV style plugs outer contact ground connection is maintained through the center contact mating cycle. Center contacts prevent shock hazards when the connectors are unmated. Mfg. part no. 1705-14 has conventional construction with crimp contacts. Mfg. part nos. 1705-1 and 1705-2 feature weatherproof K-Grip, Jr. construction with crimp contacts.

Mfg. Part No.	For RG/U Cable	Stock No.	Price Each	
			1-99	500-999
1705-14	59 59A, 59B, 62, 62B, 62C, 71, 71A, 71B, 210	93F4891	28.72	26.33
1705-1	59, 59A, 59B, 62, 62B, 62C, 210	46F6039	19.14	17.54
1705-2	58*, 58A*, 58C, 141, 141A	46F6038	19.83	18.18

MHV STYLE RF COAXIAL STRAIGHT PLUGS

MHV style plugs are a forerunner of the SHV series plug and are designed for the high-voltage applications of BNC connectors. Feature K-Grip Jr. construction with crimp contacts. Note: Not intermateable with BNC connectors.

KV59-37	58*, 58A*, 58C, 141, 141A	94B9910	18.67	17.12
KV-59-23	59, 59A, 59B, 62, 62B, 62C, 210	66F3872	20.48	17.07

10KV/20KV RF COAXIAL STRAIGHT PLUGS

10KV and 20KV plugs feature special high voltage interfaces and are ideally suited for pulse applications.

1065-1 OD	58C	98F991	19.03	17.44
1765-1	8, 8A, 11, 11A, 213	17B5453	77.62	71.14

SHV WITHIN SERIES ADAPTER

1709-3	Tee Adapter, Plug-Jack-Plug	98F4036	76.91	70.50
--------	-----------------------------	---------	-------	-------

*Crimping the center contact is not recommended when crimp contact is indicated (8865)

TechCast® Product Training

Use the library of online training modules located on our homepage under Useful Tools, with specific guidance for complex solutions.

(148857)

50-OHM ZDC SERIES SMA CONNECTORS



Fig. 1

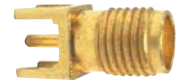

Fig. 2

- DC - 3GHz frequency range
- Durability: 50 cycles minimum

RIGHT ANGLE JACK (GOLD/NICKEL/COPPER-PLATED BERYLLIUM COPPER CONTACTS)

Mfg. Part No.	Fig.	Coaxial Termination	Connector Mounting	Stock No.	Price Each	
					1-49	50-99
5-1814400-1	1	Solder	PC Board	78M7245	2.60	2.29

STRAIGHT JACK (GOLD-PLATED PHOSPHOR BRONZE CONTACTS)

5-1814832-1	2	Solder	PC Board	78M7270	2.23	1.97
-------------	---	--------	----------	---------	------	------

(108533)

50-OHM SMA CONNECTORS

Just Added



Fig. 1

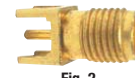

Fig. 2



Fig. 3

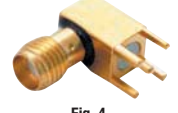

Fig. 4



Fig. 5



Fig. 6



Fig. 7

STRAIGHT JACK

Mfg. Part No.	Fig.	RG/U	Coaxial Termination	Connector Mounting	Body Length (mm)	Stock No.	Price Each
6053226-1	Solder	Cable	13.40	96M0684	19.01
2052-1215-02	1	...	Solder	Panel	9.530	48H8301	14.64
1053265-1	Solder	Panel	10.80	10H7145	23.94
1052566-1	1	...	Solder	Panel	12.10	96M0586	10.89
1052897-1	1	...	Solder	Panel	12.10	39C5926	13.48
2006-5010-00	...	405, 0.085" Semi-Rigid	Solder	Panel	12.74	24K0965	17.44
1053226-1	Solder	Panel	13.41	48F5698	23.25
1052527-1	1	...	Solder	Panel	14.00	96M0585	9.29
1059453-1	Solder	Panel	18.03	10H7148	29.36
2062 0000 00	2	...	Solder	PC Board	9.53	48F5715	14.57
5449692-1	2	...	Solder	PC Board	16.80	96M0682	15.84
6274096-1	2	...	Solder	PC Board	19.94	96M0688	21.80
1053182-1	Solder	PC Board	11.50	10H7138	22.42
1053241-1	Solder	PC Board	11.50	10H7140	26.66
1053251-1	Solder	PC Board	11.50	10H7142	29.53
1408492-1	Solder	PC Board	19.74	96M0643	14.80

STRAIGHT BULKHEAD JACK

1051942-1	...	174, 188, 316	Solder	Panel	34.93	96M0584	24.80
1053086-1	Solder	Panel	15.60	10H7129	31.37
1053111-1	3	...	Solder	Panel	17.00	96M0588	12.03
1274061-2	Solder	Panel	15.87	11H0791	13.40

RIGHT ANGLE JACK

1052986-1	Solder	Panel	11.10	08R5312	19.72
1052987-1	Solder	Panel	29.00	96M0587	27.65
1053392-1	4	...	Solder	PC Board	14.81	96M0589	12.05

STRAIGHT PLUG

1051664-1	...	174	Crimp	Cable	38.10	96M0583	14.00
1408442-1	...	LMR240	Crimp	Cable	27.71	96M0641	6.61
1050602-1	...	402, 0.141" Semi-Rigid	Crimp	Cable	8.500	10H7000	28.73
1050611-1	...	405, 0.085" Semi-Rigid	Crimp	Cable	8.500	96M0582	14.33
2031 5003 00	...	188	Solder	Cable	17.50	88F5713	12.02
1050762-1	5	402, 0.141" Semi-Rigid	Solder	Cable	11.10	94H7651	12.27
1056227-1	5	402, 0.141" Semi-Rigid	Solder	Cable	11.10	10H7212	12.88
1050541-1	5	402, 0.141" Semi-Rigid	Solder	Cable	11.40	85C0583	6.92
1050735-1	5	405, 0.085" Semi-Rigid	Solder	Cable	11.10	10H7007	8.88
2001 5032 00	5	405, 0.085" Semi-Rigid	Solder	Cable	11.10	48F5708	5.77

CONTINUED

50-OHM SMA CONNECTORS (CONT.)

STRAIGHT PLUG

Mfg. Part No.	Fig.	RG/U	Coaxial Termination	Connector Mounting	Body Length (mm)	Stock No.	Price Each
● 2001-5032-02	...	405, 0.085" Semi-Rigid	Solder	Cable	11.10	82K9454	4.13
● 1056231-1	5	.047" Semi-Rigid	Solder	Cable	11.18	96M0591	63.68

RIGHT ANGLE PLUG

● 1051139-1	...	188	Clamp	Cable	16.90	10H7035	28.88
● 1408524-1	6	LMR240	Crimp	Cable	17.55	96M0644	18.67
● 2037 5100 02	6	178, 196	Crimp	Cable	16.90	07H7989	11.86
● 2037-5008-00	...	188A	Crimp	Cable	16.90	19K4914	10.46
● 1051151-1	7	402, 0.141" Semi-Rigid	Solder	Cable	17.15	07H4213	13.10
● 2007 5055 00	7	405, 0.085" Semi-Rigid	Solder	Cable	17.15	07H7901	24.69
● 2007 7985 02	7	405, 0.085" Semi-Rigid	Solder	Cable	17.15	94C2609	14.08
● 1052063-1	7	55, 58, 141, 142, 223, 400	Solder	Cable	16.92	10H7066	12.96

STRAIGHT PLUG TERMINATOR

● 1460802-1	11.00	96M0645	7.90
-------------	-----	-----	-----	-----	-------	---------	------

STRAIGHT ADAPTER

Mfg. Part No.	Convert From	Convert To	Frequency Max. (GHz)	Stock No.	Price Each			
					1-24	25-49	50-99	100-249
● 2082 5133 02	SMA Plug	SMA Jack	18.0	91B2397	26.85	25.36	23.75	21.26

RIGHT ANGLE ADAPTER

● 2088 0000 02	SMA Plug	SMA Jack	12.4	92C8661	23.78	21.40	20.21	19.88
● 2088 1230 02	SMA Plug	SMA Jack	18.0	88C9627	23.52	21.17	19.99	18.82

(115843)

AMP SMA COAXIAL CONNECTORS

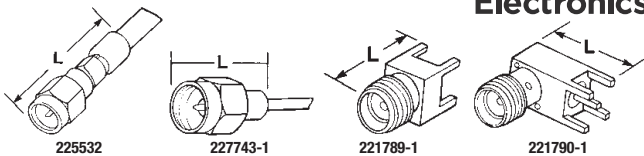

Features Teflon® dielectric. Qualified to MIL-C-39012. Order hand tools separately. Go online or call.

SMA PLUGS — CABLE MOUNT, STRAIGHT

Mfg. Part No.	RG/U	Description	Dim. L	Stock No.	Price Each	
● 1051654-1	188	Commercial-Grade	1.187"	07H7920	9.16	8.24
● 1056456-1	141, 303, 58	Commercial-Grade	0.802"	07H8249	11.82	10.37
● 1050721-1	174, 188, 316	Commercial-Grade	0.750"	10H7004	21.39	18.78
● 1051655-1	316	Commercial-Grade	1.187"	26H3402	9.05	8.60
● 1050756-1	402 Semi-Rigid	Commercial-Grade	0.330"	67C2369	7.98	7.01
● 5447647-2	142, 142A, 142B, 400	HEX	1.080"	16M3272	5.04	4.33
● 225532-4	174, 188, 188A, 316	MIL Style	0.950"	89F4356	17.25	14.84
● 221117-4	...	Commercial-Grade	1.188"	52K4317	16.51	14.50
● 5447647-3	174, 188A, 316	HEX	...	42K8722	3.78	2.99
● 225532-3	142, 142A, 142B, 400, Belden 9246	MIL Style	1.030"	89F4352	18.15	15.61
● 5-225532-8	161, 179, 179A, 179B, 187, 187A, 9221	MIL Style	...	10M8222	17.40	14.97
● 227743-1	402 Semi-Rigid	...	0.544"	89F4331	14.04	12.33
● 1050776-1	402 Semi-Rigid	...	0.444"	10H7012	21.34	18.74
● 1050525-1	402 Semi-Rigid	...	0.440"	48F5707	5.77	5.19
● 1045351-1	405 Semi-Rigid	10H6834	13.47	11.82
● 228583-1	405 Semi-Rigid	...	0.670"	89F2945	38.00	37.10
● 221447-1	405 Semi-Rigid	...	0.510"	93F3214	10.67	10.16
● 1050859-1	405 Semi-Rigid	...	0.500"	10H7016	9.17	8.73
● 1050770-1	405 Semi Rigid	...	0.437"	71M0784	5.18	4.93

SMA PLUGS — CABLE MOUNT, RIGHT ANGLE

● 1052066-1	188	...	0.666	48F5717	11.46	10.31
● 1052067-1	188	...	0.666	73M8545	11.35	10.79

SMA JACKS — CABLE MOUNT

● 1050854-1	402 Semi-Rigid	Commercial-Grade	0.500"	85C4957	10.54	8.43
● 1051013-1	402 Semi-Rigid	...	0.760"	73M8543	15.33	13.80

SMA JACKS — PANEL MOUNT

● 1052902-1	0.500"	73M8548	13.34	12.68
● 1052552-1	0.965"	73M8546	7.12	6.73
● 1052523-1	1.080"	48F5711	6.46	5.82
● 1052901-1	0.500"	73M8547	16.87	15.18

➔ CONTINUED ➔

AMP SMA COAXIAL CONNECTORS (CONT.)

SMA JACKS — PANEL MOUNT

Mfg. Part No.	RG/U	Description	Dim. L	Stock No.	Price Each	
					1-9	10-24
● 1052522-1	1.080"	48F6789	7.34	6.61
● 1052551-1	1.080"	48F5712	9.01	8.56

SMA JACKS — PANEL MOUNT, RIGHT ANGLE

● 1052978-1	1.210"	73M8549	15.18	14.42
-------------	-----	-----	--------	---------	-------	-------

SMA JACKS — PC MOUNT

Mfg. Part No.	Style	Description	Dim. L	Stock No.	Price Each
● 221789-1	Straight	PCB Vertical	0.530"	89F4338	8.11
● 2056 0000 00	Straight	PCB Bulkhead, Rear Mount	...	07H8085	7.75
● 1053221-1	Vertical	PCB Bulkhead, Rear Mount	...	07H8097	10.32
● 221789-3	Vertical	PCB Straight	0.530"	12H6649	11.82
● 221790-1	Right-Angle	PCB	0.600"	89F2962	16.42
● 1053378-1	Right-Angle	PCB	0.583"	48F5716	12.68

SMA ADAPTERS

● 221643-1	Adapter (Jack-Jack)	PCB Bulkhead	0.880"	89F2960	20.27
● 2084 0000 02	Adapter (Jack-Jack)	PCB Bulkhead Rear Mount	...	17C1708	21.10
● 1054868-1	Adapter (Jack-Jack)	Straight PCB Bulkhead Rear Mount	...	92B1873	21.30
● 1054875-1	Adapter (Jack-Jack)	Straight PCB Bulkhead Rear Mount	...	71M0785	47.93
● 1054874-1	Adapter (Jack-Jack)	Bulkhead Rear Mount	0.875"	10H7168	38.47
● 1054425-1	Adapter (Plug-Jack)	Straight	...	07H8142	24.87
● 1053488-1	Adapter (Jack-Jack)	Straight	...	10H7156	23.96
● 1053634-1	Adapter (Plug-Jack)	Straight	0.878"	10H7161	22.28
● 1055064-1	Adapter (Plug-Jack)	Right Angle	...	17C6338	26.46
● 1053489-1	Adapter (Jack-Jack)	Straight	...	50B8814	17.05
● 1053514-1	Adapter (Jack-Jack)	Straight	0.875"	73M8550	28.40
● 1053635-1	Adapter (Plug-Plug)	Straight	...	50B8815	19.68
● 1055047-1	Adapter (Plug-Plug)	Right Angle	...	10H7176	25.76

(8251)

901 SERIES 50-OHM SMA COAXIAL CONNECTORS

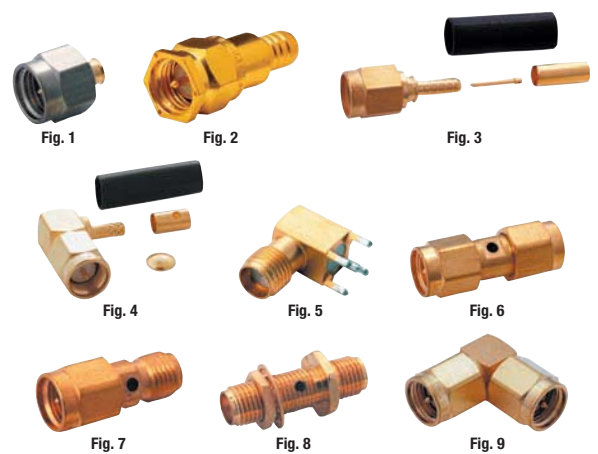

50-ohm SMA connectors are semi-precision connectors with electrical performance from 0 to 18GHz. Built in accordance with MIL-C-39012. Applications include base stations, instrumentation, process control, Mil/Aero, telecom and PC/LAN. Order mfg. part no. 227-944 crimp tool separately on page 1040. Die sets for crimp tool available on pages 1039-1040.

50-OHM STRAIGHT PLUGS

Mfg. Part No.	Fig.	RG/U	Description	Stock No.	Price Each
● 901-9723	1	0.086" Semi Rigid 405	Plug, Solder	50F2433	7.07
● 901-9808	1	0.041" Semi Rigid 402	Plug, Solder	93F7534	6.75
● 901-103	1	55, 58, 142, 223	Plug, Solder	39F2950	75.08
● 901-9201-1A	1	0.141" Semi Rigid 402	Plug, Solder	50F2434	8.31
● 901-101-15	2	55B, 142B, 223, 400	Plug, Solder	83F6687	35.89
● 901-128-11	...	174, 316	Plug, Solder	83F6688	59.45
● 901-9723-10	1	405, Semi Rigid .085	Plug, Solder	83F6698	10.50
● 901-9201-2A	1	405, Semi Rigid .085	Plug, Solder	93F1311	17.84
● 901-9601-3SF	2	174, 188A, 316, Belden 7805A	Plug, Crimp/Solder	93F1350	18.61

➔ CONTINUED ➔

RF COAX SUBMINIATURE

901 SERIES 50-OHM SMA COAXIAL CONNECTORS (CONT.)

Mfg. Part No.	Fig.	RG/U	Description	Stock No.	Price Each 1-9
901-10024-RFX	1	174, 188, 316	Plug, Crimp/Solder	19C5336	3.49
901-9601-1SF	2	55, 142, 223, 400	Plug, Crimp/Solder	93F1349	31.32
901-101	...	55, 142, 223, 400	Plug, Crimp/Solder	82K8913	35.97
901-9805-HP	...	405	Pre-Assem. Factory Set Interface	83F6706	7.70
901-9601-3	2	174, 179, 187, 188, 316	Plug, Crimp, Gold-Plated	39F3327	21.14
901-9501-3	3	174A, 179B, 187A, 188A, 316	Plug, Crimp	39F3325	19.52
901-9511-1	3	55, 142, 223, 400	Plug, Crimp, Gold-Plated+	93F1340	10.60
901-9511-1SF	3	55, 142, 223, 400	Plug, Crimp, Passivated+	93F1341	8.96
901-9511-1SFC	3	55, 142, 223, 400	Plug, Crimp, Passivated	93F7535	15.56
901-9511-12SF	3	174, 188, 316	Plug, Crimp, Passivated	93F1343	9.42
901-9511-2	3	58, 141, Belden YR20621	Plug, Crimp, Gold-Plated+	93F7537	22.80
901-9511-3	3	174, 179, 187, 188, 316	Plug, Crimp, Gold-Plated+	39F3326	8.11
901-9511-3SF	3	174, 179, 187, 188, 316	Plug, Crimp, Passivated+	93F1342	6.56

50-OHM RIGHT-ANGLE PLUGS

901-9521-3	4	174, 179, 179B, 187, 187A, 188, 188A, 316	Plug, Solder	39F3328	25.89
901-9531-1	4	55, 142, 223, 400	Plug, Crimp, Gold-Plated	50F2435	13.89
901-9531-1SF	4	55, 142, 223, 400	Plug, Crimp, Passivated	93F1344	13.27
901-9531-3	4	174, 179, 187, 188, 316	Plug, Crimp, Gold-Plated	39F3329	11.32
901-9531-3SF	4	174, 179, 187, 188, 316	Plug, Crimp, Passivated	93F1345	10.16
901-9531-12	4	316	Plug, Crimp, Gold-Plated	93F1346	15.40
901-9531-12SF	4	316	Plug, Crimp, Passivated	93F1347	10.21
901-148-15	...	142, 400	Plug, Crimp	63M2621	109.09

50-OHM BULKHEAD JACK

901-9610-3	...	174, 179, 187, 188, 316	Bulkhead Jack, Crimp, Gold-Plated	90F8492	19.13
901-9602-3	...	177, 178A	Bulkhead Jack, Crimp, Gold-Plated	53H9700	34.24
901-9602-3SF	...	174, 188A, 316, 7805A	Bulkhead Jack, Crimp, Passivated	93F7605	44.38
901-9610-3SF	...	174, 188A, 316, 7805A	Bulkhead Jack, Crimp, Passivated	93F1352	17.26
901-9610-1SF	...	55, 142, 223, 400	Bulkhead Jack, Crimp, Passivated	93F1351	28.01
901-9610-12SF	...	316 Double Braided	Bulkhead Jack, Crimp/Solder	93F1353	20.42
901-9202-2A	...	0.085, 0.087 Semi-Rigid	Bulkhead Jack, Solder, Gold-Plated	93F7602	31.92

+Non-captivated solder contact

BULKHEAD JACK RECEPTACLES - FEMALE CONTACTS

Mfg. Part No.	Fig.	Description	Stock No.	Price Each 1-9
901-9211	...	Rear Mount, Solder Cup, Gold-Plated	90F8493	31.22
901-9220	...	Front or Rear Mount, Blunt Post Terminal, Gold-Plated	90F8495	12.07
901-9856	...	Bulkhead Jack, Press-Fit, Gold-Plated	83F6713	18.22
901-9841	...	Bulkhead, Blunt Post	83F6710	11.57

PCB JACK RECEPTACLES - GOLD-PLATED

901-143-4	...	Right Angle, Blunt Post	83F6690	25.15
901-9850	...	Straight, Edge-Mount	83F6711	28.01
901-144-4	...	Straight, PCB Mount	83F6693	20.48
901-10003	...	Straight, Edge-Mount	19C5328	10.51
901-10019	...	Straight, Edge-Mount	19C5332	13.77
901-143-3	...	Right Angle, Blunt Post	83F6689	23.54
901-144-2	...	Straight, Blunt Post	83F6692	28.01
901-9215-3CCSF	...	Flange, Tab	83F6697	17.01

PCB JACK RECEPTACLES - GOLD-PLATED 4-LEG/BLUNT POST TERMINALS

901-144	...	Straight Jack, 0.155" Legs	98F1495	7.79
901-143	5	Angle Jack, 0.155" Legs	51F3841	10.92

IN-SERIES ADAPTERS

901-9217-SF	...	Straight Jack-Jack, Passivated	93F7608	56.28
901-9217	...	Straight Jack-Jack, Gold-Plated	50F2437	51.94

901 SERIES 50-OHM SMA COAXIAL CONNECTORS (CONT.)

IN-SERIES ADAPTERS

Mfg. Part No.	Fig.	Description	Stock No.	Price Each 1-9
901-9218	6	Straight Plug-Plug, Gold-Plated	50F2438	59.82
901-9218-SF	6	Straight Plug-Plug, Passivated	93F1329	54.62
901-9216	7	Straight Plug-Jack, Gold-Plated	50F2436	38.49
901-9209A	8	Bulkhead Jack-Jack, Gold-Plated	51F3842	13.53
901-9209-ASF	8	Bulkhead Jack-Jack, Passivated	93F1323	12.30
901-125-11	...	Angle Plug-Jack, Gold-Plated	89F2878	49.29
901-125-11SF	...	Angle Plug-Jack, Passivated	01F388	52.61
901-9219-ASF	...	Angle Plug-Jack, Passivated	93F1330	34.92
901-274	9	Angle Plug-Plug, Gold-Plated	73K1501	111.13

50-OHM BRASS SMA COAXIAL CONNECTORS

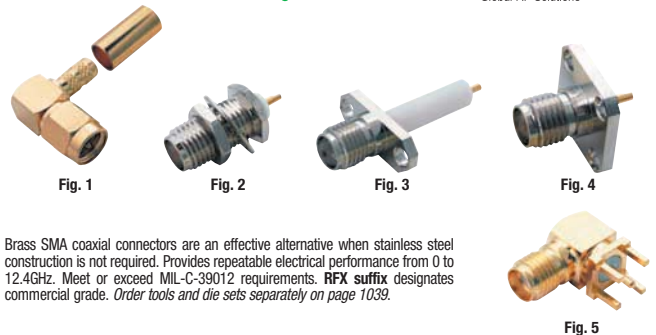

Brass SMA coaxial connectors are an effective alternative when stainless steel construction is not required. Provides repeatable electrical performance from 0 to 12.4GHz. Meet or exceed MIL-C-39012 requirements. RFX suffix designates commercial grade. Order tools and die sets separately on page 1039.

STRAIGHT PLUGS

Mfg. Part No.	Fig.	RG/U	Description	Stock No.	Price Each 1-9
901-9870	...	58, 141, 89907	Crimp, Gold-Plated	01F2196	4.77
901-9916	...	174, 188, 316	Crimp, Gold-Plated	01F2195	4.00
901-9871	...	141, 223	Crimp, Gold-Plated	01F2197	6.27
901-9876-RFX	...	58	Crimp, Nickel-Plated	01F2200	2.68
901-9877-RFX	...	174, 188, 316	Crimp, Nickel-Plated	01F2201	2.64
901-9867-RFX	...	405, Semi-Rigid 0.085	Solder, Gold-Plated	83F6719	2.62
901-9868-RFX	...	402, Semi-Rigid 0.141	Solder, Gold-Plated	19C5344	3.39
901-9221-1A	...	402, Semi Rigid .141	Solder/Solder, Gold-Plated	93F1332	23.21

RIGHT-ANGLE PLUGS

901-9873	1	58	Crimp, Gold-Plated	01F2194	10.58
901-9872	1	174, 188, 316	Crimp, Gold-Plated	01F2193	8.34
901-9880-RFX	1	58	Crimp, Nickel-Plated	01F2198	4.61
901-9881-RFX	1	174, 188, 316	Crimp, Nickel-Plated	01F2199	4.54

BULKHEAD JACK RECEPTACLES

Mfg. Part No.	Fig.	Description	Stock No.	Price Each 1-9
901-9875	...	Rear Mount, Solder Cup, Gold-Plated	83F6721	6.67
901-9879-RFX	...	Rear Mount, Solder Cup, Nickel-Plated	83F6724	6.28
901-9889-RFX	...	Rear Mount, Solder Cup, Nickel-Plated	01F2202	4.08
901-9890-RFX	2	Rear Mount, Solder Cup, Nickel-Plated	01F2203	5.05
901-9215	...	Panel Jack, 4-Hole Flange, Gold-Plated	39F3332	25.63

PANEL PLUG RECEPTACLES

901-9891-RFX	3	2-Hole Panel Mount, Post, Nickel-Plated	01F2204	6.99
901-9887-RFX	...	4-Hole Panel Mount, Post, Nickel-Plated	01F2205	7.72
901-9893-RFX	...	2-Hole Panel Mount, Solder Cup, Ni Plated	01F2209	4.67
901-9892-RFX	4	4-Hole Panel Mount, Solder Cup, Ni Plated	01F2206	5.74

PC BOARD JACK RECEPTACLES

901-143-6RFX	5	Right-Angle, 4-Leg, Blunt Post, Gold-Plated	34C8150	5.23
901-9894-RFX	5	Right-Angle, 4-Leg, Blunt Post, Gold-Plated	83F6734	6.72
901-144-8RFX	...	Straight, 4-Leg, Blunt Post, Gold-Plated	34C8151	3.13
901-9895-RFX	...	Straight, 4-Leg, Blunt Post, Gold-Plated	83F6735	3.93

Huge Expanded Selection of Semiconductors

Go online to find new technologies and proven solutions from world-class and specialist suppliers.

CONTINUED

(148843)

RF COAX SUBMINIATURE

CANNON 50-OHM SUBMINIATURE RF COAXIAL SMA CONNECTORS

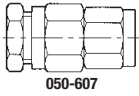

050-607

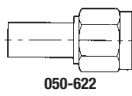

050-622

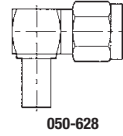

050-628

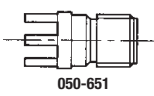

050-651

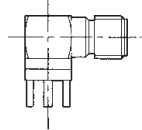

050-653

Meet MIL-C-39012 specifications. Frequency range: 0 to 18GHz. Mechanical: captivated or noncaptivated screw-on coupling interface solder contact. Coupling nut size: 0.312" hex. Field repairable. Medium power.

SMA SERIES PLUGS — RG-316 CABLE

Mfg. Part No.	Description	Stock No.	Price Each	
			1-9	10-24
050-607-3188310	Straight Plug, Clamp, Flexible	90F2518	28.26	23.36
050-622-9188310	Straight Plug, Crimp, Flexible	90F2499	23.92	19.77
050-628-9188310	Right-Angle Plug, Crimp, Flexible	90F2505	14.59	12.06
A50-624-9188310	Straight Plug, Crimp, Capt. Contact	90F2501	62.71	51.56

SMA SERIES JACK RECEPTACLES — PC BOARD MOUNT

Mfg. Part No.	Description	Stock No.	Price Each	
			1-9	10-24
050-651-0000310	Straight Jack	01F1411	18.38	15.11
050-653-0000310	Right-Angle Jack	95F6334	72.50	59.62

(8718)

50-OHM SMA REVERSE POLARITY CONNECTORS



Fig. 1



Fig. 2



Fig. 3



Fig. 4



Fig. 5



Fig. 6



Fig. 7

- Frequency range: 0 - 18GHz depending on connector
- Gold-plated brass contacts (jacks)
- Gold-plated beryllium copper contacts (plugs)
- Brass bodies with gold or nickel plating
- Temp. range: -65°C to +165°C

Reverse polarity connectors employ female contacts in the plug connector and male contacts in the jack connector.

STRAIGHT JACK

Mfg. Part No.	Fig.	RG Cable Type	Coaxial Termination	Connector Mounting	Stock No.	Price Each	
						1-9	10-24
142-4701-201	1	...	Solder	PC Board	01C1713	8.92	8.35

STRAIGHT BULKHEAD JACK

142-4304-401	2	188, 316	Crimp/Solder	Cable	01C1683	13.70	12.82
142-4307-401	2	58, 141, 303	Crimp/Solder	Cable	01C1685	15.76	14.74
142-4701-801	3	...	Solder	PC Board	94B4392	10.17	9.52

RIGHT ANGLE BULKHEAD JACK

142-4701-501	4	...	Solder	PC Board	90B2138	9.25	8.65
--------------	---	-----	--------	----------	---------	------	------

STRAIGHT PLUG

142-4403-001	5	161, 174, 188, 316	Crimp/Solder	Cable	01C1689	15.06	14.08
142-4404-001	5	188, 316	Crimp/Solder	Cable	01C1693	15.60	14.60
142-4407-001	5	58, 141, 303	Crimp/Solder	Cable	01C1697	17.02	15.92

RIGHT ANGLE PLUG

142-4403-101	6	161, 174, 188, 316	Crimp/Solder	Cable	01C1691	16.16	15.12
142-4404-101	7	188, 316	Crimp/Solder	Cable	01C1695	16.72	15.64
142-4407-101	6	58, 141, 303	Crimp/Solder	Cable	01C1699	16.72	15.64
142-4435-101	6	LMR240	Crimp/Solder	Cable	01C1707	16.08	15.04

(110572)

50-OHM STAINLESS STEEL SMA CONNECTORS

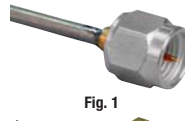

Fig. 1

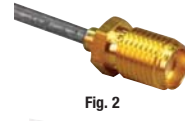

Fig. 2



Fig. 3



Fig. 4



Fig. 5



Fig. 6



Fig. 7



Fig. 8



Fig. 9



Fig. 10



Fig. 11



Fig. 12

- Meet MIL-PRF-39012 performance requirements
- Designs are based on 50Ω system impedance per MIL-STD-348
- Operates at frequencies up to 26.5GHz

Body material: stainless steel. Contact material: brass (plugs), Beryllium copper (jacks). Contact finish: gold.

STRAIGHT SOLDER PLUGS — WITH CONTACT, CAPTIVE NUT THIN WALL

Mfg. Part No.	Fig.	Body Plating	RG Cable Type	Stock No.	Price Each		
					1-9	10-49	50-99
141-0693-002	1	Gold	405, 0.085" Semi-Rigid	06M3415	7.86	7.34	6.82
141-0694-002	1	Gold	402, 0.141" Semi-Rigid	06M3417	5.73	5.35	4.92

STRAIGHT SOLDER PLUG — WITHOUT CONTACT, THREAD-ON NUT CONNECTOR INTERFACE FOR 0.141" CABLE

141-0694-012	1	Gold	402, 0.141" Semi-Rigid	06M3418	3.93	3.67	3.41
--------------	---	------	------------------------	---------	------	------	------

STRAIGHT SOLDER PLUGS — WITH CAPTIVATED SOLDERLESS CONTACT, CAPTIVE NUT AND THICK WALL INTERFACE

141-0693-062	1	Gold	405, 0.085" Semi-Rigid	06M3416	7.19	6.71	6.23
141-0694-062	1	Gold	402, 0.141" Semi-Rigid	06M3419	7.41	6.92	6.43

STRAIGHT SOLDER JACKS

141-0593-001	2	Gold	405, 0.085" Semi-Rigid	06M3409	5.73	5.35	4.97
141-0594-001	2	Gold	402, 0.141" Semi-Rigid	06M3412	5.73	5.35	4.97

STRAIGHT SOLDER BULKHEAD JACKS — WITH O-RING

141-0593-401	3	Gold	405, 0.085" Semi-Rigid	06M3410	8.98	8.39	7.79
141-0594-401	3	Gold	402, 0.141" Semi-Rigid	06M3413	8.98	8.39	7.79

STRAIGHT SOLDER BULKHEAD JACKS — WITH CAPTIVATED SOLDERLESS CONTACTS AND O-RING

141-0593-421	3	Gold	405, 0.085" Semi-Rigid	06M3411	11.23	10.48	9.74
141-0594-421	3	Gold	402, 0.141" Semi-Rigid	06M3414	9.77	9.12	8.47

STRAIGHT CRIMP PLUGS — 3-PIECE SOLDER OR CRIMP CAPTIVATED CONTACTS

141-0403-012	1	Passivated Steel	161, 174, 188, 316, LMR-100, HPF-100, RF-100	06M3401	5.22	4.87	4.53
141-0404-012	1	Passivated Steel	188DS, 316DS	06M3403	6.03	5.63	5.23
141-0407-012	1	Passivated Steel	58, 141, 303, LMR-195, HPF-195, RF-195	06M3405	5.93	5.54	5.15
141-0408-012	1	Passivated Steel	55, 142, 223, 400	06M3407	7.19	6.71	6.23

RIGHT ANGLE CRIMP PLUGS — CAPTIVATED CONTACTS

141-0403-102	4	Passivated Steel	161, 174, 188, 316	06M3402	8.76	8.18	7.60
141-0404-102	4	Passivated Steel	188DS, 316DS	06M3404	10.44	9.75	9.06
141-0407-102	4	Passivated Steel	58, 141, 303	06M3406	5.95	5.56	5.16
141-0408-102	4	Passivated Steel	55, 142, 223, 400	06M3408	7.97	7.44	6.92

STRAIGHT CRIMP BULKHEAD JACKS — 3-PIECE SOLDER OR CRIMP CAPTIVATED CONTACTS

141-0303-412	5	Passivated Steel	161, 174, 188, 316	06M3397	6.51	6.08	5.65
141-0304-412	5	Passivated Steel	188DS, 316DS	06M3398	6.62	6.19	5.75
141-0307-412	5	Passivated Steel	58, 141, 303	06M3399	9.54	8.91	8.28
141-0308-412	5	Passivated Steel	55, 142, 223, 400	06M3400	9.54	8.91	8.28

▶ CONTINUED ▶

RF COAX SUBMINIATURE

50-OHM STAINLESS STEEL SMA CONNECTORS (CONT.)

RIGHT ANGLE PC MOUNT JACK RECEPTACLE

Mfg. Part No.	Fig.	Body Plating	Pin Length (in.)	Stock No.	Price Each		
					1-9	10-49	50-99
141-0701-301	6	Gold	0.155	06M3421	11.79	11.01	10.22

STRAIGHT PC MOUNT JACK RECEPTACLE

141-0701-201	7	Gold	0.155	06M3420	5.65	5.28	4.90
--------------	---	------	-------	---------	------	------	------

REAR MOUNT BULKHEAD JACK RECEPTACLE

Mfg. Part No.	Fig.	Body Plating	Panel Thickness (in.)	Stock No.	Price Each		
					1-9	10-49	50-99
141-0701-402	8	Passivated Steel	0.045	06M3422	5.38	5.02	4.67

FLANGE MOUNT JACK RECEPTABLES — FLUSH DIELECTRIC

Mfg. Part No.	Fig.	Body Plating	No. of Mounting Holes	Tail Length (in.)	Stock No.	Price Each		
						1-9	10-49	50-99
141-0701-602	9	Passivated Steel	2	0.200	06M3423	9.54	8.91	8.28
141-0701-612	10	Passivated Steel	4	0.200	06M3424	6.76	6.32	5.87

FLANGE MOUNT JACK RECEPTABLES — EXTENDED DIELECTRIC

141-0701-622	11	Passivated Steel	2	0.702	06M3425	9.88	9.22	8.57
141-0701-632	12	Passivated Steel	4	0.702	06M3426	9.65	9.02	8.38

(89358)

50-OHM HIGH FREQUENCY SMA END LAUNCH CONNECTORS

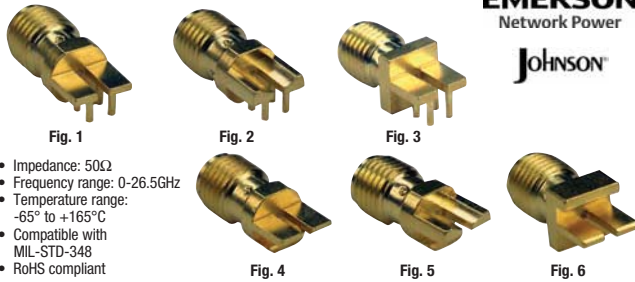

- Impedance: 50Ω
- Frequency range: 0-26.5GHz
- Temperature range: -65° to +165°C
- Compatible with MIL-STD-348
- RoHS compliant

Body material: brass. Contact material: beryllium copper. Insulator material: teflon. Gold contacts.

JACK RECEPTACLE — PC MOUNT, ROUND BODY

Mfg. Part No.	Fig.	Pin Dia. (in.)	Board Thickness (in.)	Leg Thickness (in.)	Stock No.	Price Each		
						1-9	10-49	50-99
142-0761-801	1	0.01	...	0.32	18K5110	10.38	9.12	7.86
142-0761-821	1	0.015	...	0.4	41K0119	10.38	9.12	7.86
142-0761-881	2	0.01	...	0.6	41K0124	9.98	8.77	7.56
142-0771-821	2	0.015	...	0.6	41K0126	10.38	9.12	7.86

JACK RECEPTACLE — PC MOUNT, SQUARE BODY

142-0761-811	3	0.01	...	0.32	41K0118	10.38	9.12	7.86
142-0761-831	3	0.015	...	0.4	41K0120	10.38	9.12	7.86

JACK RECEPTACLE — EDGE MOUNT, ROUND BODY

142-0761-841	4	0.01	0.062	0.32	41K0121	10.38	9.12	7.86
142-0761-861	4	0.015	0.062	0.4	41K0122	10.38	9.12	7.86
142-0761-891	5	0.01	0.062	0.6	41K0125	10.38	9.12	7.86
142-0771-831	5	0.015	0.062	0.6	41K0127	10.38	9.12	7.86

JACK RECEPTACLE — EDGE MOUNT, SQUARE BODY

142-0761-851	6	0.01	0.062	0.32	36K2551	10.38	9.12	7.86
142-0761-871	6	0.015	0.062	0.4	41K0123	10.38	9.12	7.86

(85725)

50-OHM SMA COAXIAL CONNECTORS

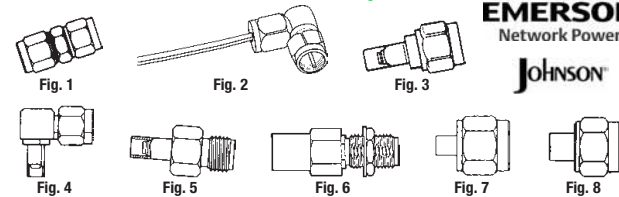

➤ CONTINUED ➤

50-OHM SMA COAXIAL CONNECTORS (CONT.)

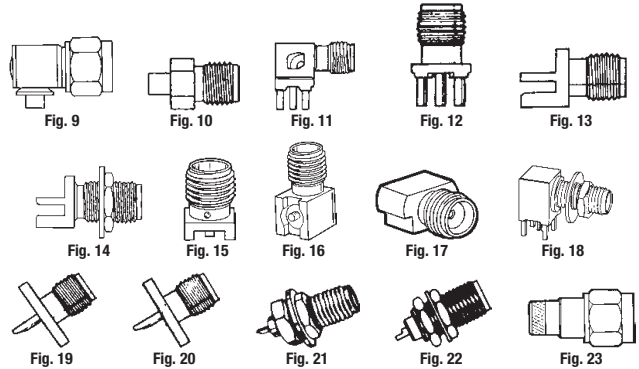

Flexible cable-mount plugs and jacks feature clamp or crimp termination. Frequency response DC to 12.4GHz. Semi-rigid cable-mount plugs and jacks feature solder termination. Frequency response DC to 26.5GHz except mfg. part no. 142-0693-101 and 142-0694-101 which are 12.4GHz. PC board mount, surface mount, and flange mount receptacle jacks have a frequency response DC to 18GHz. All feature gold-plated contacts.

STRAIGHT PLUGS — CAPTIVATED CONTACT

Mfg. Part No.	Fig.	Cable Term.	Plating	RG Cable Type	Stock No.	Price Each		
						1-9	10-49	50-99
142-0203-011	1	Clamp	Nickel	161, 174, 179, 187, 188, 316	93F9173	13.92	12.22	10.53
142-0203-016	1	Clamp	Nickel	161, 174, 179, 187, 188, 316	08B810	12.71	11.16	9.61
142-0207-011	1	Clamp	Gold	58, 141, 303	98F8955	22.31	19.59	16.87
142-0207-016	1	Clamp	Nickel	58, 141, 303	08B811	21.06	18.49	15.92

FLEXIBLE CABLE MOUNT RIGHT ANGLE PLUGS — CAPTIVATED CONTACT

142-0203-106	2	Clamp	Nickel	161, 174, 179, 187, 188, 316	98F5610	10.35	9.08	7.82
142-0203-101	2	Clamp	Gold	161, 174, 179, 187, 188, 316	81F4463	11.50	10.10	8.70
142-0207-106	2	Clamp	Nickel	58, 141, 303	88F1377	11.62	10.21	8.79
142-0403-101	4	Crimp/Solder	Gold	161, 174, 188, 316	76K1101	9.92	8.71	7.50
142-0404-101	2	Crimp/Solder	Gold	188DS, 316DS	08B855	9.47	8.32	7.16
142-0408-101	2	Crimp/Solder	Gold	58, 142, 223, 400	08B864	10.83	9.51	8.19
142-0439-101	4	Crimp/Solder	Gold	LMR200, HPF200, RF200	01C1629	13.05	11.46	9.87
142-0435-101	4	Crimp/Solder	Gold	LMR200, HPF200, RF200	01C1625	14.50	12.73	10.96

STRAIGHT PLUGS — 3PC. SOLDER OR CRIMP CAPTIVATED CONTACT

142-0402-011	3	Crimp/Solder	Gold	178, 196	83F6831	8.56	7.52	6.47
142-0403-011	3	Crimp/Solder	Gold	161, 174, 179, 187, 188, 316	81F4452	6.40	5.62	4.84
142-0403-016	3	Crimp/Solder	Nickel	161, 174, 179, 187, 188, 316	95F9619	6.12	5.38	4.63
142-0407-011	3	Crimp/Solder	Gold	58, 141, 303	95F9624	8.15	7.15	6.16
142-0408-011	3	Crimp/Solder	Gold	58, 141, 303	95F9625	8.39	7.37	6.34

STRAIGHT PLUGS — 3PC. CAPTIVATED CONTACT

142-0439-001	3	Crimp/Solder	Gold	LMR200, HPF200, RF200	01C1627	9.28	8.15	7.02
142-0435-001	3	Crimp/Solder	Gold	LMR200, HPF200, RF200	01C1623	9.28	8.15	7.02

SEMI-RIGID STRAIGHT PLUG — WITH CONTACT, CAPTIVE NUT THIN WALL CONNECTOR INTERFACE FOR 0.141" CABLE

142-0693-006	3	Solder	Nickel	405, 0.085" Semi-Rigid	67H5851	4.98	4.30	3.70
--------------	---	--------	--------	------------------------	---------	------	------	------

SEMI-RIGID STRAIGHT PLUGS — WITHOUT CONTACT, THREAD-ON NUT

142-0694-011	8	Solder	Gold	402, 0.141" Semi-Rigid	51F2970	3.00	2.63	2.27
142-0694-016	8	Solder	Nickel	402, 0.141" Semi-Rigid	81F4461	2.46	2.16	1.86

SEMI-RIGID STRAIGHT PLUG — WITHOUT CONTACT, SLIDE-ON NUT

142-0694-021	8	Solder	Gold	402, 0.141" Semi-Rigid	51F2971	2.22	1.95	1.68
--------------	---	--------	------	------------------------	---------	------	------	------

SEMI-RIGID STRAIGHT PLUG — WITH CAPTIVATED SOLDERLESS CONTACT, CAPTIVE NUT

142-0693-061	3	Solder	Gold	405, 0.085" Semi-Rigid	91C4669	8.28	7.27	6.26
142-0694-061	3	Solder	Gold	405, 0.085" Semi-Rigid	41K0116	8.28	7.27	6.26
142-0694-066	3	Solder	Nickel	402, 0.141" Semi-Rigid	41K0117	7.78	6.83	5.88

SEMI-RIGID STRAIGHT PLUG — WITH CONTACT, CAPTIVE NUT

142-0693-001	7	Solder	Gold	405, 0.085" Semi-Rigid	51F2968	5.20	4.56	3.93
--------------	---	--------	------	------------------------	---------	------	------	------

➤ CONTINUED ➤

RF COAX SUBMINIATURE

SMA CONNECTORS AND ADAPTERS (CONT.)

Mfg. Part No.	Description	Stock No.	Price Each	
			1-24	25-49
● 4297	SMA Female-to-"N" Male Adapter	89F367	18.60	17.67
● 4298	SMA Male-to-"N" Female Adapter	89F368	18.39	17.46
● 4299	SMA Female-to-"N" Female Adapter	89F369	18.39	17.46

(90524)

50-OHM SMA RF CONNECTORS AND ADAPTERS

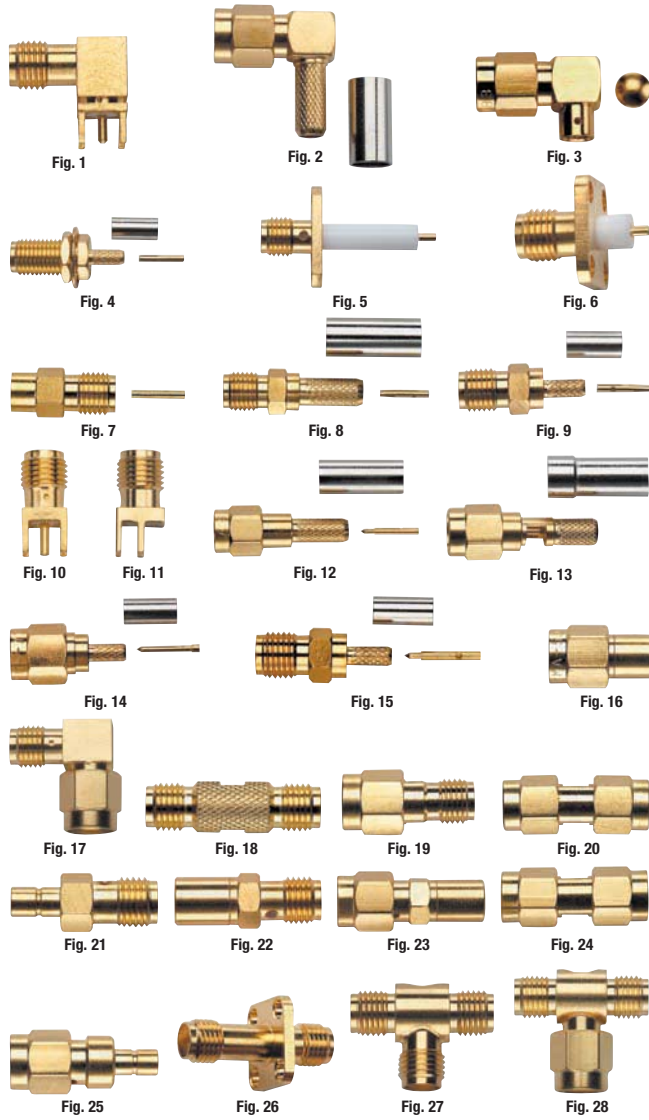

- Bandwidth up to 18 GHz
- Meets MIL-C-39012, IEC 169-15, CECC 22110

- Gold-plated brass contacts (plugs)
- Gold-plated beryllium copper contacts (jacks)

RIGHT ANGLE JACK

Mfg. Part No.	Fig.	RG/U	Coaxial Termination	Connector Mounting	Stock No.	Price Each
● 72971	1	...	Solder	PC Board	77M7296	4.21

RIGHT ANGLE PLUG

● 72958	2	58	Crimp	Cable	77M7283	5.23
● 72960	2	142, 400	Crimp	Cable	77M7285	5.42
● 72959	3	141, 174, 188, 316	Crimp	Cable	77M7284	6.47

STRAIGHT BULKHEAD JACK

● 72956	4	174, 178, 188, 316	Crimp	Cable	77M7282	4.95
---------	---	--------------------	-------	-------	---------	------

STRAIGHT FLANGED JACK

● 72961	5	...	Crimp	Panel	77M7286	3.68
● 72962	6	...	Crimp	Panel	77M7287	5.05

▶ CONTINUED ▶

50-OHM SMA RF CONNECTORS AND ADAPTERS (CONT.)

STRAIGHT JACK

Mfg. Part No.	Fig.	RG/U	Coaxial Termination	Connector Mounting	Stock No.	Price Each
● 72952	7	141	Crimp	Cable	77M7279	4.90
● 72953	8	142, 400	Crimp	Cable	77M7280	5.18
● 72954	9	174, 188, 316	Crimp	Cable	77M7281	4.90
● 72963	10	...	Solder	PC Board	77M7288	3.01
● 72970	11	...	Solder	PC Board	77M7295	4.53

STRAIGHT PLUG

● 72943	12	58	Crimp	Cable	77M7274	4.35
● 72945	12	142, 400	Crimp	Cable	77M7276	4.95
● 72944	13	141	Crimp	Cable	77M7275	4.68
● 72946	14	174, 188, 316	Crimp	Cable	77M7277	4.15
● 72950	15	174, 188, 316	Crimp	Cable	77M7278	4.86
● 72975	16	...	Crimp	Cable	76M8969	18.20

RIGHT ANGLE ADAPTER

Mfg. Part No.	Fig.	Convert From	Convert To	Stock No.	Price Each
● 72965	17	SMA Plug	SMA Jack	77M7290	9.57

STRAIGHT ADAPTER

● 72964	18	SMA Plug	SMA Plug	77M7289	6.33
● 72966	19	SMA Jack	SMA Jack	77M7291	6.80
● 72967	20	SMA Jack	SMA Jack	77M7292	12.15
● 72974	21	SMA Jack	SMA Plug	77M7298	7.02
● 72976	22	SMA Plug	SMB Plug	77M7299	7.30
● 72977	23	SMA Plug	SMB Jack	77M7300	7.17
● 72978	24	SMA Jack	SMB Plug	77M7301	9.61
● 72979	25	SMA Jack	SMB Jack	77M7302	9.48

STRAIGHT FLANGED ADAPTER

● 72973	26	SMA Jack	SMA Jack	77M7297	12.10
---------	----	----------	----------	---------	-------

TEE ADAPTER

● 72968	27	SMA Jack	SMA Jack Jack	77M7293	12.01
● 72969	28	SMA Jack	SMA Jack Plug	77M7294	11.69

(107914)

50-OHM SMA JACK END CONNECTORS



- Specifications
- Impedance: 50 Ω
 - Frequency Range: 0-18 GHz
 - Contact Resistance: 3 mΩ
 - Insulation Resistance: 5000 MΩ
 - Body: Brass - Gold Plated



Gold plated center contact & body with Teflon insulation

Mfg. Part No.	Mounting Type	PCB Thickness (mm)	Stock No.	Price Each
● 19-70-TGG	Bulkhead	1.73	42M2864	3.64
● 19-70-1-TGG	PC Board	1.73	42M2865	3.20
● 19-70-4-TGG	PC Board	1.22	42M2866	3.20

(116653)

SMA CONNECTORS AND ADAPTERS

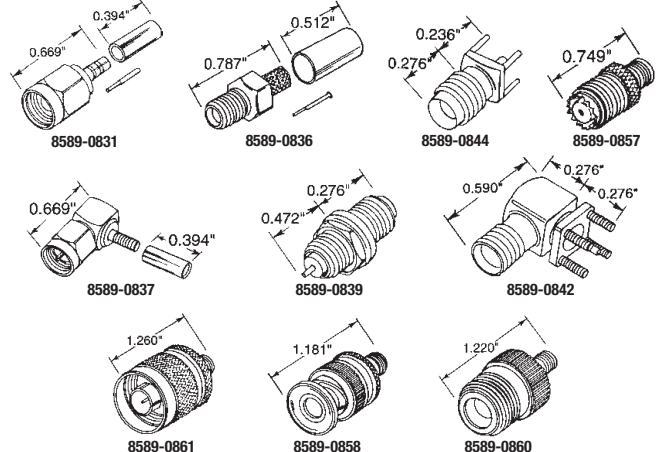

▶ CONTINUED ▶

SMA CONNECTORS AND ADAPTERS (CONT.)

Contact, body, and/or insulating material of SMA adapters is identified in the table as follows: "N" indicates nickel body plating; "G" indicates, gold contact or body plating; and "T" indicates, Teflon® insulation.

Mfg. Part No.	Description	Stock No.	Price Each	
			1-49	100-249
● SPC10049	Male Crimp Plug, Reverse Polarity (Gender), for RG-58/U	18C1922	4.20	
● 8589-0833	Male Crimp Plug for RG-58/U; N, G, T	16N2715	6.46	
● 19-03F-4-TGG	Straight Plug for RG-58; G, G, T	26M6010	2.35	
● 8589-0865	Male Crimp Plug for RG-58/U; G, G, T	16N2747	7.79	
● MC23546	Male Crimp Plug for RG-142/U	96M8830	3.50	
● SPC10048	Male Crimp Plug, Reverse Polarity (Gender), for RG-174/U	18C1921	6.39	
● SPC20110	Male Crimp Plug for RG-174/U; 3-Pc., N, G, T	82K9790	5.34	
● 8589-0832	Male Crimp Plug for RG-174/U; 3-Pc., G, G, T	16N2714	9.61	
● MC23554	Male Crimp Plug for RG-174/U	96M8838	2.50	
● MC23602	Male Crimp Plug for RG-174/U	96M8886	3.63	
● MC23560	Male Crimp Plug for RG-142/U	96M8844	2.01	
● 8589-0872	Male Solder Plug for 0.141 Semi-Rigid Cable; N, G, T	16N2754	6.50	
● MC23588	Male Solder Plug for RG-405/U	96M8872	3.00	
● MC23582	Male R/A Crimp Plug for RG-58/U	96M8866	3.45	
● 8589-0838	Male R/A Crimp Plug for RG-58/U; N, G, T	16N2720	4.14	
● MC23561	Male R/A Crimp Plug for RG-142/U	96M8845	3.45	
● MC23551	Male R/A Crimp Plug for RG-174/U	96M8835	3.43	
● 8589-0837	Male R/A Crimp Plug for RG-174/U; N, G, T	16N2719	7.58	
● 8589-0835	Female Crimp for RG-174/U; N, G, T	16N2717	9.73	
● 8589-0836	Female Crimp for RG-58/U; N, G, T	16N2718	10.72	
● 8589-0844	Female Vertical PCB Mount; N, G, T	16N2726	8.62	
● SPC20113	Female Vertical PCB Mount; G, G, T	82K9793	12.62	
● 19-46-1-TGG	Bulkhead Jack PCB Mount; G, G, T	26M6022	3.36	
● MC23549	Female Jack PCB Mount	96M8833	4.25	
● 19-70-1-TGG	Jack, End Launch; G, G, T	42M2865	3.20	
● MC23579	Female Jack, Solder, Panel Mount	96M8863	3.63	
● MC23586	Female PCB Jack, Solder	96M8870	3.63	
● MC23590	Female Solder Jack for RG-405/U	96M8874	5.00	
● MC23592	Female Crimp Jack for RG-174/188/316U	96M8876	3.10	
● 8589-0839	Female Bulkhead, Solder, Front Mount; N, G, T	16N2721	9.30	
● 19-49-5-TGG	Bulkhead Jack R/A PCB Mount; G, G, T	26M6024	4.56	
● 8589-0842	Female R/A PCB Mount; N, G, T	16N2724	15.24	
● 8589-0843	Female R/A PCB Mount; G, G, T	16N2725	4.69	
● MC23591	Female R/A Bulkhead, Solder	96M8875	5.25	
● 8589-0846	R/A Adapter, SMA Male to SMA Female; N, G, T	16N2728	15.41	
● 8589-0847	R/A Adapter, SMA Male to SMA Female; G, G, T	16N2729	9.27	
● 8589-0848	Adapter, SMA Male to SMA Male; N, G, T	16N2730	12.28	
● 8589-0849	Adapter, SMA Male to SMA Male; G, G, T	16N2731	16.12	
● SPC20111	Adapter, SMA Female to SMA Female; N, G, T	82K9791	7.09	
● 8589-0851	Adapter, SMA Female to SMA Male; N, G, T	16N2733	18.47	
● 8589-0852	Adapter, SMA Female to SMA Male; G, G, T	16N2734	17.01	
● 8589-0853	Bulkhead Adapter, SMA Female to Female; G, G, T	16N2735	19.54	
● 8589-0867	Adapter, SMA Male to N Female; N, G, T	16N2749	15.03	
● 8589-0868	Adapter, SMA Male to N Male; N, G, T	16N2750	14.52	
● 8589-0855	Adapter, SMA Male to BNC Male; N, G, T	16N2737	9.68	
● SPC20112	Adapter, SMA Male to BNC Female; N, G, T	82K9792	17.75	
● 8589-0856	Adapter, SMA Female to Mini UHF Male; N, G, T	16N2738	7.46	
● 8589-0857	Adapter, SMA Female to Mini UHF Female; N, G, T	16N2739	12.03	
● 8589-0858	Adapter, SMA Female to BNC Male; N, G, T	16N2740	13.80	
● 8589-0859	Adapter, SMA Female to BNC Male; G, G, T	16N2741	20.39	
● 8589-0860	Adapter, SMA Female to N Female; N, G, T	16N2742	15.79	
● 8589-0861	Adapter, SMA Female to N Male; N, G, T	16N2743	20.30	

(8853)

AMP 50-OHM QMA SNAP-ON SMA COAXIAL CONNECTORS



- Positive snap-on interface facilitates assembly
- Excellent RF performance to 6GHz
- Ideal for communications and industrial applications



Mfg. Part No.	Description	Mounting	Cable Type	Stock No.	Price Each	
					1-99	100-249
● 1408333-1	Straight Cable Plug	Crimp	174, 188, 316	07J2529	6.46	5.87
● 1408333-3	Straight Cable Plug	Crimp	316	07J2530	9.09	8.41

➔ CONTINUED ➔

AMP 50-OHM QMA SNAP-ON SMA COAXIAL CONNECTORS (CONT.)

Mfg. Part No.	Description	Mounting	Cable Type	Stock No.	Price Each	
					1-99	100-249
● 1408336-3	Right-Angle Cable Plug	Crimp	316	07J2531	12.36	11.44
● 1408339-3	Bulkhead Cable Jack	Crimp	316	07J2533	10.39	9.61
● 1408339-5	Bulkhead Cable Jack	Crimp	400	07J2534	10.39	9.61
● 1408339-7	Bulkhead Cable Jack	Crimp	58	07J2535	7.57	7.01
● 1408332-1	Straight Jack Receptacle	PC Board	...	07J2528	2.85	2.59
● 1408337-1	Right-Angle Jack Receptacle	PC Board	...	07J2532	6.99	6.47

AMP 50-OHM QMA CONNECTORS



- Frequency range: DC to 6GHz
- Nickel-plated brass shells and bodies
- Gold-plated beryllium copper contacts (jacks)

- Gold-plated brass contacts (plugs)
- Temp. range: -40°C to +125°C

STRAIGHT JACK

Mfg. Part No.	RG/U	Coaxial Termination	Connector Mounting	Stock No.	Price Each
● 1408338-7	58, 141, 303	Crimp	Cable	96M0631	5.20
● 1408338-1	174, 188, 316	Crimp	Cable	96M0630	5.20
● 1408348-1	402, 0.141" Semi-Rigid	Solder	Cable	96M0638	5.69
● 1408341-1	...	Solder	Panel	96M0634	8.27

STRAIGHT BULKHEAD JACK

● 1408339-1	174, 188, 316	Crimp	Panel	96M0632	7.06
● 1408349-1	402, 0.141" Semi-Rigid	Solder	Panel	96M0639	7.80
● 1408340-1	...	Solder	Microstrip	96M0633	5.72

RIGHT ANGLE BULKHEAD JACK

● 1408463-3	...	Solder	Panel	96M0642	5.83
-------------	-----	--------	-------	---------	------

STRAIGHT PLUG

● 1408333-7	58, 141, 303	Crimp	Cable	96M0628	7.31
● 1408346-1	402, 0.141" Semi-Rigid	Solder	Cable	96M0636	7.62

RIGHT ANGLE PLUG

● 1408336-7	58, 141, 303	Crimp	Cable	96M0629	7.50
● 1408336-1	174, 188, 316	Crimp	Cable	29M9078	8.38
● 1408347-1	402, 0.141" Semi-Rigid	Solder	Cable	96M0637	9.21

TERMINATOR PLUG

● 619271-1	74M8550	14.34
------------	-----	-----	-----	---------	-------

STRAIGHT ADAPTERS

Mfg. Part No.	Convert From	Convert To	Stock No.	Price Each	
				1-24	100-249
● 1408343-1	QMA Jack	SMA Plug	96M0635	9.05	
● 1408393-1	QMA Plug	SMA Plug	96M0640	12.82	

(114898)

element14
 Research, Refine, Design Seamlessly
 Experience the definitive technical portal/community for electronic design engineers at www.element-14.com

(148859)

RF COAX SUBMINIATURE

50 OHM QMA CONNECTORS



Fig. 1



Fig. 2



Fig. 3



Fig. 4



Fig. 5

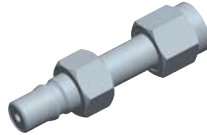

Fig. 6

- Operates at the same electrical performance as SMA up to 6GHz
- Snap-on interface for quick and easy installation
- Snap-lock mechanism removes requirement for wrench clearance
- Rotatable 360° after connection for flexibility with installation

- Durability, 100 cycles
- Retention force of interface, 60 N (13.5 lb.) min.
- Temperature range, -40° to +80°C
- Pin contact material gold over brass
- Socket contact material gold over beryllium copper

STRAIGHT PLUGS

Mfg. Part No.	Fig.	Cable Term.	RG Cable Type	Stock No.	Price Each		
					1-9	10-24	25-99
930-108P-51S	1	Solder	402, 0.141" Semi-Rigid	09J5617	10.59	9.68	8.93
930-120P-51S	1	Crimp/Solder	58	09J5627	10.78	9.84	9.10

RIGHT ANGLE PLUGS

930-103P-51A	2	Solder	402, 0.141" Semi-Rigid	09J5613	11.71	10.70	9.88
930-114P-51A	2	Crimp/Solder	316	09J5621	8.75	8.03	7.52
930-118P-51A	2	Crimp	174, 188A, 316, Belden 7805A	09J5625	13.16	12.13	10.86

PC MOUNT STRAIGHT JACKS

Mfg. Part No.	Fig.	Pin Length (in.)	Stock No.	Price Each		
				1-9	10-24	25-99
930-116J-51P	3	0.158	09J5623	8.82	8.14	7.28

ADAPTERS

Mfg. Part No.	Fig.	Convert From	Convert To	Stock No.	Price Each		
					1-9	10-24	25-99
930-130A-51S	4	QMA Plug	SMA Plug	09J5637	82.76	54.28	40.72
930-101A-51S	4	QMA Plug	SMA Jack	81H1286	49.86	45.57	41.95
930-100A-51S	5	QMA Jack	SMA Jack	68H8482	51.62	46.46	42.23
930-131A-51S	6	QMA Jack	SMA Plug	09J5638	56.69	51.53	47.24

(80541)

AMP 50-OHM QSL CONNECTORS, CABLE ASSEMBLIES, AND ANTENNAS



NEW TECHNOLOGY

- Features**
- Designed for RG 174 and 316 cable
 - 3-port QSL footprint (mm): 10 H x 17.5 W x 12.5 D
- Specifications**
- Frequency range: DC to 6GHz
 - Voltage rating: 60VAC (rms)
 - Current rating (per port): 5A max.
 - Temp. range: -40°C to +85°C

- Applications**
- Mobile antenna, GPS and radio systems
 - PDA, PCS and other handheld applications
 - Wireless communications systems
 - Satellite communications, broadcast and multimedia
 - Automotive telematics
 - WiFi / WiMax antenna mobility and communications
 - Broadcast, set top box and integration media
 - PCle and WNIC cards

The QSL RF connector system offers a low profile coaxial cable insulation displacement interface. It acts as a replacement for SMA, BNC and other RF connectors. These connectors are platform expandable for multiple ports, configuration and color options.

▶ CONTINUED ▶

AMP 50-OHM QSL CONNECTORS, CABLE ASSEMBLIES, AND ANTENNAS (CONT.)

3-PORT RIGHT ANGLE JACKS

Mfg. Part No.	Connector Mounting	Coaxial Termination	Flange	Stock No.	Price Each		
					1-24	25-49	50-99
2016032-1	PC Board	Solder	No	03P0623	12.83	11.03	9.75
1274824-2	Panel	Solder	Yes	03P0616	12.83	11.03	9.75

3-PORT ADAPTERS

Mfg. Part No.	Convert From	Convert To	Adapter Type	Stock No.	Price Each		
					1-24	25-49	50-99
1513743-1	QSL Jack	SMA Jack	Test Board	03P0619	109.28	93.98	83.05
2016008-1	QSL Jack	UMCC Jack	Test Board	03P0622	40.95	35.22	31.13
2032605-1	QSL Plug	SMA Jack	Test Dongle	03P0624	54.50	51.23	49.05

3-PORT CABLE ASSEMBLIES

Mfg. Part No.	Description	RG/U	Length (mm)	Flange	Stock No.	Price Each	
						1-24	25-49
2015518-1	QSL Plug-to-Stripped End Leads	174	800	No	03P0621	8.58	7.38
2053075-1	QSL Plug-to-Pigtail	174	800	Yes	03P0625	8.45	7.27

ANTENNA MODULE ASSEMBLIES

Mfg. Part No.	Description	Stock No.	Price Each		
			1-4	5-9	10-24
1513711-1	3-Port QSL, 802.11 a/b/g/n and WiMax Antenna Assembly w/o Flange	03P0617	23.00	19.78	17.48
1513712-1	3-Port QSL, 802.11 a/b/g/n and WiMax Antenna Assembly w/ Flange	03P0618	25.50	21.93	19.38
1513837-1	Triple Dipole 802.11a/b/g/n Antenna Assembly w/ 3-Port QSL Connector	03P0620	26.53	22.82	20.16

(132425)

AMP SMB CONNECTORS



- Nickel-plated front body
- Tin-plated rear body
- Gold-plated brass contacts
- Quick connect/disconnect coupling style

NEW TECHNOLOGY

75-OHM JACKS

Mfg. Part No.	Body Style	Coaxial Termination	Connector Mounting	Stock No.	Price Each
					1-24
414244-1	Straight Jack	Solder	PC Board	92F1592	7.33
5221014-1	Right Angle Jack	Solder	PC Board	64M7443	7.47

50-OHM JACKS

1060455-1	Straight Jack	Solder	PC Board	73M8554	5.56
415340-1	Right Angle Jack	Solder	PC Board	13H4279	5.35
1060464-1	Right Angle Jack	Solder	PC Board	08R5317	14.66

50-OHM PLUGS

413985-1	Straight Plug	Crimp	Cable	96F7614	6.45
----------	---------------	-------	-------	---------	------

(112557)

50-OHM SMB SUBMINIATURE COAXIAL CONNECTORS

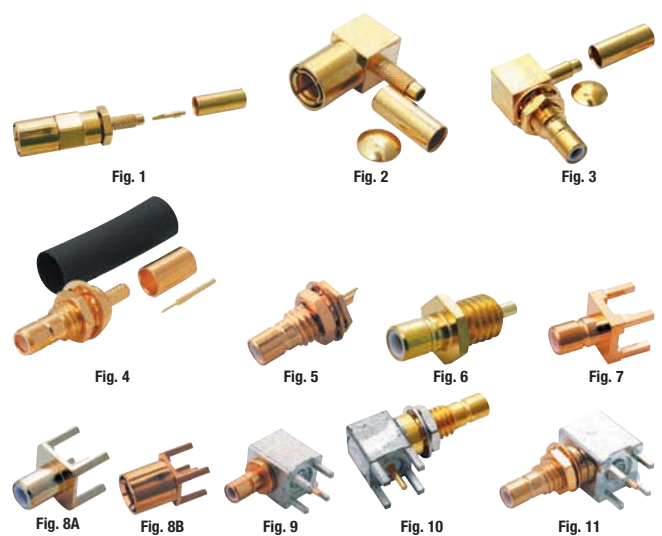

▶ CONTINUED ▶

RF COAX SUBMINIATURE

50-OHM SMB SUBMINIATURE COAXIAL CONNECTORS (CONT.)

SMB subminiature connectors feature snap-on mating and meet or exceed MIL-C-39012 requirements. Voltage rating of 335V peak. Frequency range: 0-4GHz; useable to 10GHz. Temperature range: -65°C to +165°C. Moisture seal.

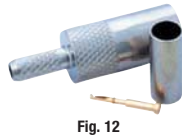

Fig. 12

STRAIGHT PLUGS — BRAID CRIMP/SOLDER FEMALE CONTACT

Mfg. Part No.	Fig.	RG/U	Body Plating	Stock No.	Price Each	
					1-9	10-24
● 903-285P-51S	1	174, 179, 187, 188, 316	Gold	90F8472	9.08	8.11
● 903-370P-51S	1	174, 179, 187, 188, 316	Nickel	93F1365	6.86	6.27
● 903-536P-71S	12	179, 187, Belden 9221	Gold	96B7184	53.15	47.36

STRAIGHT PLUG — RADIAL CRIMP FEMALE CONTACT

● 27 1	...	174, 188, 316	Gold	42F201	28.66	25.53
--------	-----	---------------	------	--------	-------	-------

RIGHT-ANGLE PLUGS — BRAID CRIMP/SOLDER FEMALE CONTACT

Mfg. Part No.	Fig.	RG/U	Body Plating	Stock No.	Price Each	
					1-9	10-24
● 903-289P-51A	2	174, 179, 187, 188, 316	Gold	90F8473	10.69	9.76
● 903-289P-51A2	2	174, 179, 187, 188, 316	Gold	01F884	3.89	3.56
● 903-367P-51A	2	174, 179, 187, 188, 316	Nickel	93F1361	11.20	10.23
● 903-367P-51A2	2	174, 179, 187, 188, 316	Nickel	66F9591	4.54	4.05
● 903-291P-51A	2	178, 196	Gold	90F8498	14.90	13.61
● 903-291P-51A1	2	178, 196	Gold	01F885	7.72	7.06
● 903-368P-51A1	2	178, 196	Nickel	66F9588	5.54	5.06

RIGHT-ANGLE BULKHEAD JACK — BRAID CRIMP/SOLDER MALE CONTACT

Mfg. Part No.	Fig.	RG/U	Body Plating	Stock No.	Price Each	
					1-9	10-24
● 903-422J-51A	3	174, 179, 187, 188, 316	Gold	93F1377	23.93	21.32

STRAIGHT BULKHEAD JACK — BRAID CRIMP/SOLDER MALE CONTACT

Mfg. Part No.	Fig.	RG/U	Body Plating	Stock No.	Price Each	
					1-9	10-24
● 903-505J-51S1	4	Double Shield 316	Nickel	01F886	7.35	6.72
● 903-505J-51S	4	174, 179, 187, 188, 316	Nickel	66F9587	7.35	6.72

BULKHEAD JACK RECEPTACLES — GOLD-PLATED BODY, SOLDER CUP TERMINALS

Mfg. Part No.	Fig.	Description	Stock No.	Price Each	
				1-9	10-24
● 903-305J-51R	5	Rear Mount	50F2441	13.72	12.22
● 903-407J-51R	5	Rear Mount	93F1373	33.37	30.48
● 903-402J-51R	6	Front Mount	93F1371	5.43	4.88
● 903-406J-51R+	6	Front Mount	93F1372	6.52	5.96

PC BOARD JACK RECEPTACLES — 4 LEG/BLUNT POST TERMINALS

Mfg. Part No.	Fig.	Description	Stock No.	Price Each	
				1-9	10-24
● 903-415J-51P	7	Gold-Plated Brass	50F2442	5.59	5.01
● 903-499J-51P	7	Gold-Plated Diecast Zinc, Snap-Lock	01F887	7.40	6.76
● 903-499J-51P2	7	Gold-Plated Diecast Zinc	66F9590	3.34	2.87
● 903-409J-53P†	8A	Slide-On Jack, Gold-Plated	66F9593	12.24	11.19
● 903-410P-53P†	8B	Slide-On Plug, Gold-Plated	66F9594	12.94	11.82
● 903-373J-51A	9	Angle, Tin-Lead-Plated, Leak Tight‡	51F3920	6.02	5.50
● 903-413J-51A	11	Angle Bulkhead, Tin-Lead-Plated, Leak Tight‡	73K1503	12.00	10.91

†Board-to-board interconnect for 0.360" spacing; +Jam nut and lockwasher ordered separately; go online or call; **No stand-off pads. ‡ Gold plated interface and contact.

ACCESSORIES

Mfg. Part No.	Description	Stock No.	Price Each	
			1-9	10-24
● 903-10408-1	Gold Plated Jam Nut	93F1379	1.42	1.26
● 903-10409-1	Gold Plated Lock Washer	93F1381	1.42	1.26

(8304)

903 SERIES 75-OHM HIGH-DENSITY, SMB COAXIAL PC BOARD JACK RECEPTACLES

PC board jack receptacles feature 4 leg/blunt post terminals. Gold-plated body and contact. TFE fluorocarbon, red insulator. SMB 75-ohm high-intensity subminiature coaxial connectors conform to the requirements of MIL-C-39012. Feature quick connect/disconnect snap-on mating. Operate to 4GHz with low reflection and are useable to 10GHz. Voltage rating for RG-188U cable: 335V. Dielectric withstanding voltage: 1000Vrms. Temperature range: -65°C to +165°C.



Amphenol® RF
Global RF Solutions



Fig. 1



Fig. 2

▶ CONTINUED ▶

903 SERIES 75-OHM HIGH-DENSITY, SMB COAXIAL PC BOARD JACK RECEPTACLES (CONT.)

Mfg. Part No.	Fig.	Description	Stock No.	Price Each	
				1-9	10-24
● 903-512J-71P	1	Jack Receptacle	52F6931	10.09	
● 903-518J-71P	1	Jack Receptacle	52F6930	13.27	
● 903-375J-53P	1	Jack Receptacle	93F1367	12.24	
● 903-519J-71P	2	Angle Jack Receptacle	52F6932	16.87	
● 903-535P-71A	...	Angle Plug	19C5362	11.39	

(8305)

CANNON 50-OHM SMB/SMC CONNECTORS



3

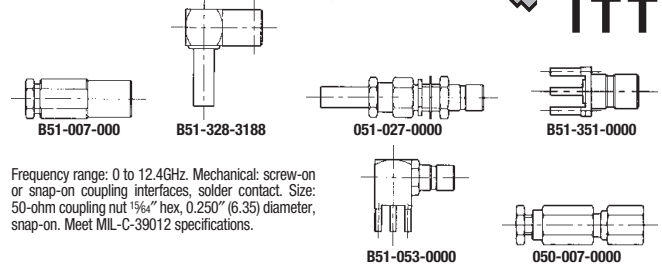

Frequency range: 0 to 12.4GHz. Mechanical: screw-on or snap-on coupling interfaces, solder contact. Size: 50-ohm coupling nut 1/16" hex, 0.250" (6.35) diameter, snap-on. Meet MIL-C-39012 specifications.

SNAP-ON CONNECTORS

Mfg. Part No.	Description	Stock No.	Price Each	
			1-9	10-24
● B51-007-0000220	St. Plug, Clamp, Flexible Coax*	90F2529	12.81	11.77
● B51-024-0000220	St. Plug, Crimp, Flexible Coax*	90F2535	6.28	5.77
● B51-328-3188220	R/A Plug, Crimp, Flexible Coax*	90F2539	10.59	9.76
● 051-043-0000220	Bulkhead Jack Receptacle, Rear Mnt.	90F2541	22.27	20.52
● 051-045-0000220	Bulkhead Jack Receptacle, Frt. Mnt.	90F2543	13.07	12.05
● B51-351-0000220	St. PCB Mount Jack	90F2546	4.69	4.32
● B51-053-0000220	R/A PCB Mount Jack	93F1825	12.06	11.11

SCREW-ON CONNECTORS

● 050-007-0000220	St. Plug, Clamp, Flexible Coax*	90F2582	21.04	19.33
● 050-024-0000220	St. Plug, Crimp, Flexible Coax*	90F2588	18.45	17.00
● B50-328-3188220	R/A Plug, Crimp, Flexible Coax*	90F2592	29.09	26.80
● 050-027-0000220	St. Bulkhead Jack, Crimp, Flex. Coax*	90F2590	10.78	9.90
● 050-043-0000220	Bulkhead Jack Receptacle, Rear Mnt.	90F2594	15.16	13.97
● B50-051-0000220	Straight PCB Mount Jack	90F2598	12.82	11.81
● B50-053-0000220	Right Angle PCB Mount Jack	90F2599	19.52	17.99

* RG-316 Cable (8719)

CANNON 50-OHM SSMB/SSMC MICROMINIATURE SNAP-ON CONNECTORS

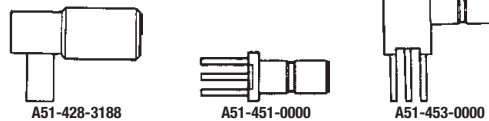

- Current Rating: 1.0 Amps DC Maximum
- Voltage Rating, Sea Level: 250Vrms
- Frequency Range: 0 to 12.4GHz

- Impedance: 50 Ohms
- Meet MIL-C-39012 Specifications

Very small (50% of SMB) coaxial connectors suitable for wireless, instrumentation, medical, PCMCIA and antenna applications.

Mfg. Part No.	Description	Stock No.	Price Each	
			1-9	10-24
● 051-424-3188220	Straight Plug, for Braided Coax	90F2600	10.41	9.27
● A51-428-3188220	Right-Angle Plug, for Braided Coax	92F5401	17.23	15.78
● A51-428-3196220	Right-Angle Plug	92F5402	7.87	7.00
● A51-451-0000220	PC Board Receptacle	90F2609	15.98	14.24
● A51-453-0000220	PC Board Receptacle, Right-Angle	90F2610	20.30	18.09

(8720)

RF COAX SUBMINIATURE

50-OHM AND MINI 75-OHM SMB AND SMC COAXIAL CONNECTORS



Frequency range: DC to 20GHz (75 ohm) or DC to 4GHz (50 ohm). Meets MIL-C-39012 spec requirements.

50-OHM SMB FLEXIBLE CABLE MOUNT CRIMP PLUGS

Mfg. Part No.	Fig.	Plating	Body Style	RG Cable Type	Stock No.	Price Each	
						1-9	10-49
131-1403-001	1	Gold	Straight Plug	161, 174, 179, 187, 188, 316	72K7355	8.71	7.52
131-1403-016	1	Nickel	Straight Plug	161, 174, 179, 187, 188, 316	72K7356	7.41	6.39
131-1404-116	1	Nickel	Right Angle Plug	179DS, 187DS, 188DS, 316DS	08B553	6.72	5.80
131-1403-101	2	Gold	Right Angle Plug	161, 174, 179, 187, 188, 316	72K7357	7.06	6.09
131-1403-116	2	Nickel	Right Angle Plug	161, 174, 179, 187, 188, 316	72K7358	5.93	5.12
131-3403-101	2	Gold	Right Angle Plug	161, 174, 179, 187, 188, 316	72K7359	10.24	8.84

50-OHM SMB FLEXIBLE NON-MAGNETIC CABLE MOUNT CRIMP PLUGS

131-9403-001	1	Gold	Straight Plug	174, 179, 187, 188, 316	10J9855	18.36	15.84
131-9403-101	2	Gold	Right Angle Plug	174, 179, 187, 188, 316	92H6918	25.81	22.27
131-9404-101	2	Gold	Right Angle Plug	179DS, 187DS, 188DS, 316DS	10J9857	25.81	22.27

75-OHM SMB FLEXIBLE CABLE MOUNT CRIMP PLUG

131-8403-101	3	Gold	Right Angle Plug	179, 187	16F3629	9.48	8.18
--------------	---	------	------------------	----------	---------	------	------

50-OHM AND 75-OHM SMB STRAIGHT PLUG DUMMY LOADS

Mfg. Part No.	Fig.	Plating	Impedance (Ω)	RG Cable Type	Stock No.	Price Each	
						1-9	10-49
131-3801-811	4	Gold	50	...	08B612	19.32	16.67

50-OHM SMB PC JACK RECEPTACLES

Mfg. Part No.	Fig.	Plating	Description	Stock No.	Price Each	
					1-9	10-49
131-1701-201	5	Gold	Straight Jack, 0.155" Leg - Die Cast	46F2190	3.58	3.09
131-1701-216	5	Nickel	Straight Jack, 0.110" Leg - Die Cast	51F2975	3.50	3.02
131-3701-201	5	Gold	Straight PC Mount Jack, 0.155" Leg	96F9763	2.90	2.50
131-3701-261	5	Gold	Straight Jack, 0.155" Leg	48F5780	2.95	2.54
131-3701-266	5	Nickel	Straight Jack, 0.155" Leg	48F6114	2.81	2.42
131-3701-271	5	Gold	Straight Jack, 0.095" Leg	48F5781	2.95	2.54
131-3701-276	5	Nickel	Straight Jack, 0.095" Leg	48F6116	2.81	2.42
131-1701-371	6	Gold	Right Angle Jack, 0.110" Leg - Die Cast	96F9761	6.72	5.80
131-1701-376	6	Nickel	Right Angle Jack, 0.110" Leg - Die Cast	50F2717	6.46	5.58
131-3701-501	6	Gold	Right Angle PC Mount Jack, 0.083" Leg Length	08B597	9.88	8.53
131-3701-301	6	Gold	Right Angle Jack, PC Board, Gold	94F3893	6.60	5.70
131-3701-621	7	Gold	2-Hole Flange Mount Straight Jack Receptacle	96F9770	9.51	8.21
131-3701-341	5	Gold	Right Angle Jack, Bulkhead	97F7154	8.48	7.32
131-3711-201	8	Gold	Right Angle Surface Mount Jack Receptacle	95F9622	4.72	4.07

50-OHM NON-MAGNETIC SMB PC JACK RECEPTACLES

131-9701-201	5	Gold	Straight Jack, 0.155" Leg	92H6981	10.93	9.43
131-9701-211	5	Gold	Straight Jack, 0.095" Leg	41K0093	10.93	9.43
131-9701-301	6	Gold	Right Angle Jack	10J9858	19.42	16.75

75-OHM SMB PC JACK RECEPTACLE

131-8701-206	5	Nickel	Straight Jack, 0.083" Leg	08B692	3.08	2.66
131-8701-261	5	Gold	Straight Jack, 0.095" Leg	01C1394	3.09	2.67
131-8701-301	5	Gold	Right-Angle Jack, 0.083" Leg	08B693	8.96	7.73

50-OHM SMC FLEXIBLE CABLE CRIMP PLUG

Mfg. Part No.	Fig.	Plating	Body Style	Cable Type	Stock No.	Price Each	
						1-9	10-49
131-6403-101	9	Gold	Right Angle Plug	RG-161, 174, 188, 316	08B635	13.71	11.83

50-OHM SMB CONNECTORS



Mfg. Part No.	Body Style	Description	RG/U	Stock No.	Price Each
					1-24
73100-0097	Right Angle Receptacle	Bulkhead, PCB ...		75K6182	5.24
73100-0103	Right Angle Receptacle	PCB ...		32M0738	3.60
73100-0207	Straight Jack	PCB ...		96H0640	2.38
73100-0248	Straight Plug	Cable, Crimp	174, 188, 316	32M0743	5.18
73100-0257	Right Angle Plug	Cable, Crimp	174, 188, 316	26H2737	6.78
73100-0259	Right Angle Receptacle	PCB ...		63K2148	3.96
73404-0001	Bulkhead Jack	Solder Pot ...		32M0798	4.48

50- AND 75-OHM SMB RF CONNECTORS

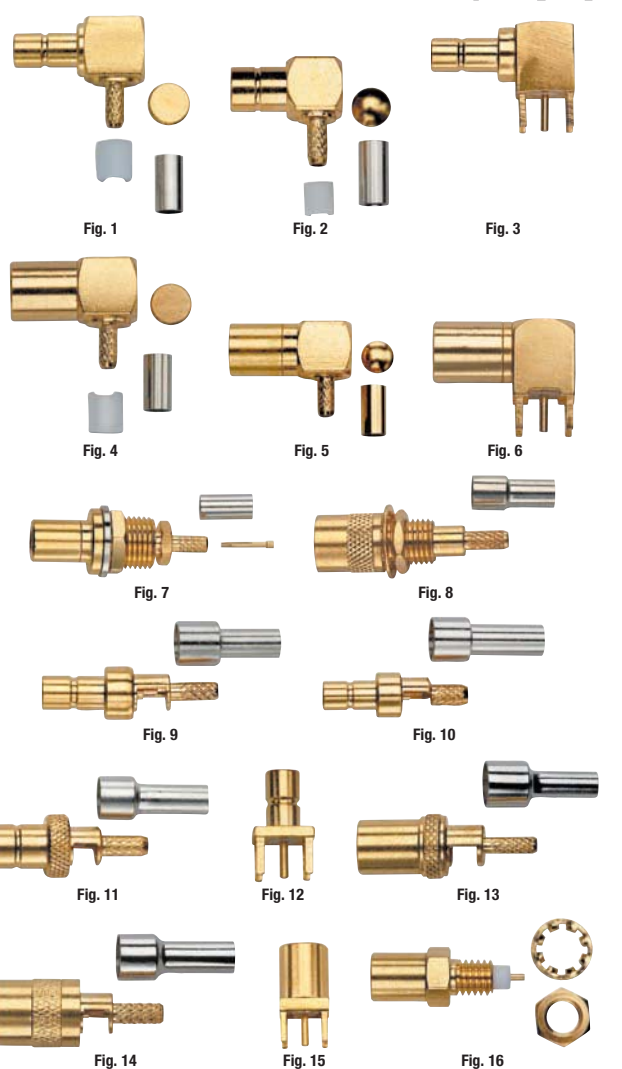

- Bandwidth up to 4 GHz
- Meets MIL-C-39012, IEC 60169-1Q, BS9210N0007, NFC93650, CECC 22130
- Gold-plated brass contacts (plugs)
- Gold-plated beryllium copper contacts (jacks)

RIGHT ANGLE JACK

Mfg. Part No.	Fig.	Impedance (Ohms)	RG/U	Coaxial Termination	Connector Mounting	Stock No.	Price Each
72991	1	50	178, 196	Crimp	Cable	77M7312	6.03
72992	1	50	174, 188, 316	Crimp	Cable	77M7313	7.12

CONTINUED

RF COAX SUBMINIATURE • RF COAX MICROMINIATURE

50- AND 75-OHM SMB RF CONNECTORS (CONT.)

Mfg. Part No.	Fig.	Impedance (Ohms)	RG/U	Coaxial Termination	Connector Mounting	Stock No.	Price Each
● 72993	2	75	179, 187	Crimp	Cable	77M7314	7.12
● 72998	3	50	...	Solder	PC Board	77M7318	3.65
RIGHT ANGLE PLUG							
● 72987	4	50	178, 196	Crimp	Cable	77M7309	6.08
● 72988	4	50	174, 188, 316	Crimp	Cable	77M7310	6.12
● 72989	5	75	179, 187	Crimp	Cable	77M7311	6.66
● 72997	6	50	...	Solder	PC Board	77M7317	5.88
STRAIGHT BULKHEAD PLUG							
● 73000	7	50	174, 188, 316	Crimp	Cable	77M7320	4.88
● 73001	8	75	179, 187	Crimp	Cable	77M7321	4.88
STRAIGHT JACK							
● 72983	9	50	178, 196	Crimp	Cable	77M7306	5.35
● 72984	10	50	174, 188, 316	Crimp	Cable	77M7307	6.89
● 72985	11	75	179, 187	Crimp	Cable	77M7308	6.89
● 72996	12	50	...	Solder	PC Board	77M7316	6.85
STRAIGHT PLUG							
● 72980	13	50	178, 196	Crimp	Cable	77M7303	5.39
● 72981	13	50	174, 188, 316	Crimp	Cable	77M7304	5.49
● 72982	14	75	179, 196	Crimp	Cable	77M7305	5.97
● 72995	15	50	...	Solder	PC Board	77M7315	5.24
● 72999	16	50	...	Solder	Panel	77M7319	5.63

(108224)

50-OHM SMC SUBMINIATURE COAXIAL CONNECTORS



Amphenol® RF
Global RF Solutions



SMC subminiature connectors feature screw-on mating and meet or exceed MIL-C-39012 requirements. Voltage rating of 375V peak. Freq. range: 0-4GHz; useable to 10GHz. Temp. range: -65°C to +165°C. Weatherproof.

50-OHM STRAIGHT PLUGS — BRAID CRIMP/SOLDER FEMALE CONTACT

Mfg. Part No.	Fig.	RG/U	Body Plating	Stock No.	1-9	10-24
● 903-284P-52S	1	174, 179, 187, 188, 316	Gold	93F1358	15.69	14.33

50-OHM RIGHT ANGLE PLUGS — BRAID CRIMP/SOLDER FEMALE CONTACT

● 903-288P-52A	2	174, 179, 187, 188, 316	Gold	93F1359	23.58	21.55
----------------	---	-------------------------	------	-------------------------	-------	-------

(8306)

SSMT CABLE ASSEMBLIES



Tyco Electronics
NEW TECHNOLOGY



SSMT surface mount interconnect system is designed to provide superior electrical and mechanical performance for wireless communication applications. The mated SSMT interface allows 360 degrees of rotation providing maximum PCB design flexibility. It has been designed to provide optimal retention for applications where shock, vibration or cable flexure may be encountered. Force to disengage by cable load (cam-out) exceeds 300 grams.

DOUBLE ENDED RIGHT ANGLE SSMT PLUG CABLE ASSEMBLIES

Mfg. Part No.	Length (mm)	Stock No.	Price Each
● 1064523-1	75	96M0617	9.13
● 1064524-1	100	96M0618	10.80
● 1081829-1	150	96M0621	6.09
● 1064530-1	200	10H7430	8.12
● 1064533-1	304.8	96M0619	8.04

RIGHT ANGLE SSMT PLUG TO PIGTAIL CABLE ASSEMBLIES

● 1064538-1	200	96M0620	7.34
-------------	-----	-------------------------	------

SSMT PLUG

Mfg. Part No.	Coaxial Termination	Connector Mounting	Contact Plating	Stock No.	Price Each		
● 1055687-1	Solder	PC Board	Gold	48F5704	1.72	1.55	1.41
● 1055688-1	Solder	PC Board	Gold	73M8551	1.42	1.29	1.18
● 1055689-1	Solder	PC Board	Gold	08R5313	1.38	1.25	1.15

(116503)

50- AND 75-OHM MCX CONNECTORS



Tyco Electronics



- Frequency range: DC to 6GHz
- Voltage: 335V (VRMS max.)
- Contact current max: 1.5A

- Mating cycles: 500 min.
- Temp. rating: -65°C to +165°C

STRAIGHT JACK

Mfg. Part No.	Impedance (Ohms)	RG/U	Coaxial Termination	Connector Mounting	Stock No.	Price Each
● 1060774-2	50	0.047" Semi-Rigid	Solder	Cable	32M0685	24.96
● 1060995-1	50	...	Solder	PC Board	96M0612	3.58
● 1330126-1	50	...	Solder	PC Board	17H0871	2.83
● 1060989-1	50	...	Solder	PC Board	93B8571	2.83
● 6061092-1	50	...	Solder	PC Board	42K7637	1.84
● 1361169-1	75	...	Solder	PC Board	96M0626	4.33

STRAIGHT BULKHEAD JACK

● 1060883-1	50	188, 316	Crimp	Panel	96M0611	9.65
-------------	----	----------	-------	-------	-------------------------	------

RIGHT ANGLE JACK

● 1061022-1	50	...	Solder	PC Board	96M0613	6.41
● 1061023-1	50	...	Solder	PC Board	96M0614	9.65
● 1061027-1	50	...	Solder	PC Board	10H7363	9.99
● 1061030-1	50	...	Solder	PC Board	96M0615	9.52

STRAIGHT PLUG

● 1060871-1	50	174, 188, 316	Crimp	Cable	96M0608	4.24
● 1060872-1	50	174, 188, 316	Crimp	Cable	96M0609	5.54
● 1060869-1	50	178, 196	Crimp	Cable	10H7356	5.54
● 1060875-1	50	316	Crimp	Cable	96M0610	7.20
● 1060875-2	50	316	Crimp	Cable	10H7357	7.58
● 1060772-2	50	0.047", Semi-Rigid	Solder	Cable	96M0607	11.36
● 1085221-1	50	...	Solder	PC Board	96M0622	5.42
● 1362990-1	75	179	Crimp	Cable	36K2812	13.20

RIGHT ANGLE PLUG

● 1330723-1	50	...	Crimp	Cable	96M0625	5.78
● 1363301-2	50	316	Crimp/Solder	Cable	96M0627	5.78
● 1060787-1	50	...	Solder	Cable	10H7353	5.54
● 1362991-1	75	179	Crimp	Cable	22J1346	7.68

(114909)

50-OHM MICROMATE™ (MMCX) COAXIAL CONNECTORS



Amphenol® RF
Global RF Solutions



Microminature connectors are designed for high-density, lightweight coaxial applications, such as wireless data, communication, and instrumentation. Feature a low-mated profile to help meet critical height requirements. Positive snap-on mating provides retention through 500 mating cycles. Connectors are compatible with all MMCX designs and accommodate industry-standard coaxial cable. Impedance: 50 ohms. Frequency range: DC-6GHz. Voltage rating: 170Vrms. Dielectric withstanding voltage: 500Vrms.

RIGHT-ANGLE CABLE PLUGS

Mfg. Part No.	Cable RG/U	Stock No.	Price Each			
● 908-43200	RG-178, 196	66F9247	7.92	7.20	6.60	6.09
● 908-43300	RG-174, 188, 316	66F9248	6.91	6.32	5.82	5.39
● 908-43400	0.086" Semi-Rigid	01F2396	14.76	13.61	12.53	11.51
● 908-43600	0.047" Semi-Rigid	01F2397	13.11	11.99	11.03	10.22

▶ CONTINUED ▶

RF COAX MICROMINIATURE

50-OHM MICROMATE™ (MMCX) COAXIAL CONNECTORS (CONT.)

STRAIGHT CABLE PLUGS

Mfg. Part No.	Cable RG/U	Stock No.	Price Each			
			1-9	10-24	25-99	100-499
● 908-41200	RG-178, 196	01F2391	8.11	7.41	6.82	6.32
● 908-41300	RG-174, 188, 316	01F2392	9.29	8.49	7.82	7.24
● 908-41400	0.086" Semi-Rigid	01F2393	25.74	23.53	21.66	20.06
● 908-41600	0.047" Semi-Rigid	01F2395	12.47	11.50	10.58	9.72

EDGE CARD OR VERTICAL MOUNT PLUG

Mfg. Part No.	Description	Stock No.	Price Each			
			1-9	10-24	25-99	100-499
● 908-21100	Brass Contacts	01F2402	9.67	8.84	8.14	7.54

STRAIGHT PC BOARD PLUG (THRU-HOLE)

● 908-21103	Brass Contacts	01F2403	19.45	17.94	16.51	15.16
● 908-22106	Gold Contacts	19C5383	12.06	10.85	9.87	9.05

JACKS

● 908-22100	Edge Card or Vertical	66F9249	8.16	7.47	6.87	6.37
● 908-22101	Surface Mount	01F2404	4.21	3.83	3.51	3.23
● 908-24100	Right-Angle PC Board Jack (Thru-Hole)	01F2405	12.26	11.03	10.03	9.20

(17345)

MCX SERIES SUBMINIATURE SNAP-ON 50-OHM CONNECTORS



Amphenol® RF
Global RF Solutions

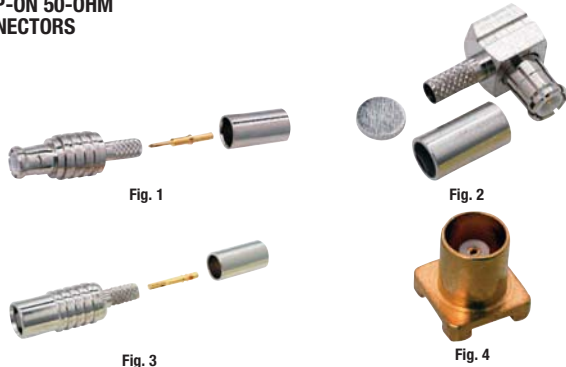

Straight and right-angle 50-ohm plugs and straight jacks accept a wide assortment of cable. Surface mount connector is also offered. Brass body plated in nickel or gold. Features a PTFE insulator, silicone rubber gasket, seamless copper tubing alloy crimp ferrules, and solder inner terminal. Low-insertion force brass male and beryllium copper female contacts, both plated with 30µ" gold. Solder-to-body termination. Low-profile design saves valuable PC board space. Quick-connect/disconnect with snap-on mating. Broadband performance with low reflection. Frequency range: 0-6GHz. Voltage rating: 335Vrms. Dielectric withstanding voltage: 1000V. Operating temp. range: -65°C to +165°C.

STRAIGHT PLUG -- FIG. 1

Mfg. Part No.	Body Finish	Outer Term.	Cable	Stock No.	Price Each	
					1-9	10-24
● 919-101P-51S1X	Nickel	Crimp	RG316	95B8314	5.60	5.09
● 919-121P-51SX	Gold	Crimp	RG178	95B8323	6.91	6.29
● 919-120P-51SX	Gold	Solder	0.086/SR	95B8322	7.53	6.88
● 919-109J-51PX	Gold	PCB Mount	...	01F813	4.23	3.85
● 919-101P-51SX	Gold	Crimp/Solder	RG 174, 188A, 316, Belden 7805A	01F812	6.85	6.23

RIGHT ANGLE PLUG -- FIG. 2

● 919-104P-51A1X	Nickel	Crimp	RG316	95B8317	6.50	5.94
● 919-104P-51AX	Gold	Crimp/Solder	RG 174, 188A, 316, Belden 7805A	01F811	6.70	6.03

STRAIGHT JACK -- FIG. 3

● 919-107J-51S1X	Nickel	Crimp	RG316	95B8319	4.76	4.35
● 919-107J-51SX	Gold	Crimp	RG316	95B8318	4.97	4.51

SURFACE MOUNT -- FIG. 4

● 919-118J-51P	Gold	95B8321	6.54	5.98
----------------	------	-----	-----	---------	------	------

(48687)

Designing a power supply?
See our huge selection of bench & module voltage regulators in this catalog and online.

(148860)

MCX SERIES 75-OHM COAXIAL CONNECTORS



Amphenol® RF
Global RF Solutions

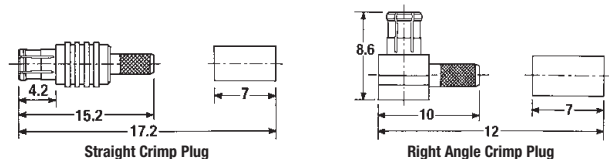

- Broadband Performance with Low Reflection DC to 6 GHz
- Quick Connect/Disconnect Snap-On Mating Reduces Installation Time
- Surface Mount PC Board Allows User to Automatically Place Connectors on Board
- 30% Reduction in Size Over SMB Series Connectors

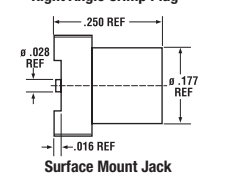

Offer reduced size, weight, durability in the telecommunications and networking marketplace, and a performance of up to 6GHz with low reflection. Require less space than the SMB series. By reducing outer diameter by 30% the 75Ω MCX series achieves a lower profile and saves valuable board space.

Mfg. Part No.	Description	Cable Size	Stock No.	Price Each	
				1-9	10-24
● 919-137P-71SX	Straight Crimp Plug	RG 179	36C3029	8.91	8.40
● 919-136P-71AX	Right Angle Crimp Plug	RG 179	36C3027	7.75	7.31
● 919-132J-71P	Surface Mount Jack	N/A	36C3026	11.96	11.28
● 919-124J-71P	Thru-Hole PC Board Jack	N/A	36C3025	10.30	9.27

(69838)

50 OHM MMCX PLUGS AND JACKS



EMERSON
Network Power



- Meets MIL-C-39012 requirements
- Impedance: 50Ω
- Frequency range: 0-6GHz
- Working voltage: 170V_{rms} at sea level
- Insulation resistance: 1000MΩ
- Plating: gold

- Engagement/disengagement force: 8lbs max. engagement; 1.4lbs min. disengagement
- Contact retention force: 20lbs min. axial force
- Cable retention: 30lbs
- Durability: 500 cycles min.
- Operating Temperature: -55°C to +155°C

50 OHM MMCX CONNECTORS

Mfg. Part No.	Fig.	Description	Cable	Stock No.	Price Each	
					1-9	10-24
● 135-3402-001	1	Straight Crimp Plug	178, 196	01F982	10.54	9.19
● 135-3403-001	1	Straight Crimp Plug	161, 174, 188, 316	01F983	10.84	9.45
● 135-3404-001	1	Straight Crimp Plug	316DS, 187DS, 188DS	08B769	14.26	12.43
● 135-3436-001	1	Straight Crimp Plug	...	01F981	10.97	9.56
● 135-3402-101	2	Right Angle Crimp Plug	178, 196	01F979	18.52	16.15
● 135-3403-101	2	Right Angle Crimp Plug	161, 174, 179, 187, 188, 316	01F980	8.53	7.44
● 135-3404-101	2	Right Angle Crimp Plug	188DS, 316DS	08B770	19.47	16.97
● 135-3436-101	2	Right Angle Crimp Plug	...	01F976	15.43	13.45
● 135-3801-201	3	Straight PC Board Plug, 0.115" Leg	...	83F6819	11.02	9.61
● 135-3693-101	2	Right Angle Solder Plug	405, 0.085" Semi-Rigid	83F6818	10.81	9.43
● 135-3701-201	4	Straight PC Board Jack, 0.115" Leg	...	01F984	4.59	4.01
● 135-3711-201	4	Straight PC Board Jack, 0.197" Leg	...	01C1450	7.17	6.26
● 135-3701-211	4	Straight PC Board Jack, 0.068" Leg	...	01F985	7.57	6.60
● 135-3701-301	5	Right Angle PC Board Jack, 0.115" Leg	...	01F976	12.80	11.16
● 135-3701-311	5	Right Angle PC Board Jack, 0.068" Leg	...	01F977	11.18	9.75
● 135-3711-801	6	End Launch Surface Mount	...	83F6820	7.24	6.31

TOOLS

Mfg. Part No.	Description	Stock No.	Price Each	
			1-9	10-24
● 140-0000-952	Hand Crimp Tool (Frame Only)	08B776	206.14	180.55
● 140-0000-953	Crimp Tool Die Set	08B777	427.52	372.79

(10826)

RF COAX MICROMINIATURE

50-OHM AND 75-OHM MCX PLUGS AND JACKS

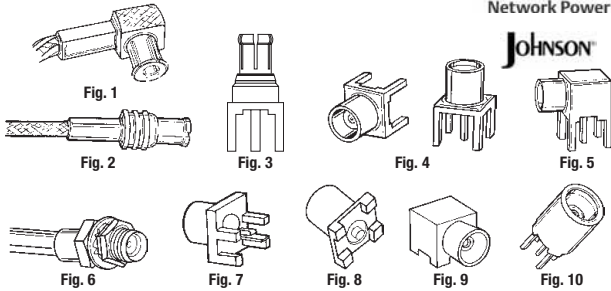

- 30% smaller than SMB
- Rugged snap-on mounting design
- Captivated contact
- Frequency range: 0-6GHz
- Working voltage at sea level: 335V_{rms}, 250V_{rms}

- Engage/disengage force: 3.4lbs max. engagement/ 5lbs typical disengagement
- Contact retention force: 4lbs min. axial force
- Durability: 500 cycles min.

50-OHM MCX CONNECTORS

Mfg. Part No.	Fig.	Description	Cable	Plating	Stock No.	Price Each	
						1-9	10-24
133-3402-101	1	Right Angle Crimp Plug	RG-178	Gold	66F3137	7.75	6.79
133-3403-101	1	Right Angle Crimp Plug	RG-316	Gold	66F3141	4.59	4.02
133-3402-106	1	Right Angle Crimp Plug	178	Nickel	66F3138	10.85	9.50
133-3403-106	1	Right Angle Crimp Plug	RG-316	Nickel	66F3142	4.60	4.03
133-3404-106	1	Right Angle Crimp Plug	RG-188DS, 316DS	Nickel	08B726	10.26	8.98
133-3693-101	1	Right Angle Solder Plug	405, 0.085" Semi-Rigid	Gold	08B735	7.35	6.44
133-3403-001	2	Straight Crimp Plug	RG-316	Gold	66F3139	3.83	3.35
133-3403-006	2	Straight Crimp Plug	316	Nickel	66F3140	9.29	8.14
133-3801-201	3	Straight PC Board Plug	...	Gold	83F6812	6.31	5.52
133-3701-201	4	Straight PC Board Jack, 0.155" Leg	...	Gold	66F3143	4.18	3.66
133-3701-206	4	Straight PC Board Jack, 0.155" Leg	...	Nickel	66F3144	7.47	6.54
133-3701-211	4	Straight PC Board Jack, 0.110" Leg	...	Gold	66F3145	6.09	5.34
133-3701-216	4	Straight PC Board Jack, 0.110" Leg	...	Nickel	66F3146	7.18	6.29
133-3701-301	5	Right Angle PC Board Jack, 0.155" Leg	...	Gold	66F3151	11.01	9.65
133-3701-306	5	Right Angle PC Board Jack, 0.155" Leg	...	Nickel	66F3152	19.45	17.04
133-3701-311	5	Right Angle PC Board Jack, 0.110" Leg	...	Gold	66F3153	20.36	17.83
133-3701-316	5	Right Angle PC Board Jack, 0.110" Leg	...	Nickel	66F3154	20.68	18.11
133-3303-401	6	Straight Crimp Bulkhead Jack	RG-161, 174, 179, 187, 188, 316	Gold	83F6815	13.09	11.47
133-3701-401	...	Straight Bulkhead Jack	...	Gold	66F8115	14.29	12.52
133-3701-406	...	Straight Bulkhead Jack	...	Nickel	88F3017	15.24	13.35
133-3701-801	7	Straight End Launch Jack	...	Gold	66F8117	6.33	5.55
133-3711-201	8	Straight Jack Surface Mount	...	Gold	83F6813	10.77	9.44
133-3711-301	9	Right Angle Jack Surface Mount	...	Gold	08B749	9.39	8.22
133-3701-231	10	Straight PC Board Jack, 0.155" Leg	...	Gold	66F3149	4.56	4.00

75-OHM MCX CONNECTORS

133-8433-101	1	Right Angle Crimp Plug	179, 179DS	Gold	83F6825	6.94	6.08
133-8434-101	1	Right Angle Crimp Plug	179, 179DS	Gold	95B3632	11.83	10.36
133-8433-001	2	Straight Crimp Plug	179, 179DS	Gold	83F6822	18.38	16.10
133-8701-201	4	Straight PC Board Jack, 0.155" Leg	...	Gold	83F6826	15.01	13.15
133-8701-211	4	Straight PC Board Jack, 0.110" Leg	...	Gold	95B3633	4.75	4.16
133-8701-311	5	Right Angle PC Board Jack, 0.110" Leg	...	Gold	95B3634	11.54	10.11

➔ CONTINUED ➔

50-OHM AND 75-OHM MCX PLUGS AND JACKS (CONT.)

75-OHM MCX CONNECTORS

Mfg. Part No.	Fig.	Description	Cable	Plating	Stock No.	Price Each	
						1-9	10-24
133-8333-401	6	Straight Crimp Bulkhead Jack	179, 179DS	Gold	83F6824	23.78	20.82
133-8701-801	7	Straight End Launch Jack	...	Gold	83F6829	6.96	6.10
133-8711-201	8	Straight Jack Surface Mount	...	Gold	01C1435	11.61	10.17

TOOLS

Mfg. Part No.	Description	Stock No.	Price Each	
			1-9	10-24
141-0000-908	Prototype Crimp Tool	08B784	827.40	724.69
140-0000-952	Hand Crimp Tool (Frame Only)	08B776	206.14	180.55
140-0000-951	Die Set (RG-178, 316)	08B775	250.33	219.25

MCX, MMCX RF CONNECTORS

MCX Subminiature snap-on connector is 30% smaller than an SMB. MMCX is a microminiature snap-on connector 45% smaller than an SMB. Operating frequency to 6 GHz.



Mfg. Part No.	Description	Gender	Stock No.	Price Each	
				1-9	10-24
73415-0991	MMCX, Straight edge mount	Receptacle	63K9065	2.56	
73415-1631	MCX 75-ohm vertical PCB	Receptacle	32M0809	2.90	
73413-0040	SSMCX Vertical PCB SMT	Receptacle	32M0800	2.09	
73413-0050	SSMCX Vertical PCB Thru hole	Receptacle	32M0801	2.29	
73415-4670	SSMCX PCB Edge mount	Plug	32M0824	4.07	
73415-4680	SSMCX Straight 1.32mm cable	Plug	12M6446	2.47	
73415-4760	SSMCX Straight 1.32mm cable	Receptacle	32M0825	2.55	
73413-0060	SSMCX R/A 1.32mm cable	Plug	32M0802	4.62	

50-OHM MMCX SERIES CONNECTORS



Specifications

- Impedance: 50 Ω
- Frequency Range: 6 GHz
- VSWR - Straight: 1.2 : 1
- VSWR - RA: 1.3 : 1
- Body: Gold Plated Beryllium Copper
- Center Contact: Gold Plated Beryllium Copper
- Dielectric: Teflon



MMCX series connectors feature low RF leakage and a snap-on coupling.

DIRECT SOLDER CONNECTORS - FOR SEMI RIGID CABLE

Mfg. Part No.	Description	RG/U	Stock No.	Price Each	
				1-9	10-24
37-02V-2-TGG	Right Angle Plug	405	25M2717	4.10	

CRIMP CONNECTORS - FOR FLEXIBLE CABLE

37-01L-5-TGG	Straight Plug	174	25M2712	3.23
37-01M-6-TGG	Straight Plug	178	25M2713	3.29
37-03L-3-TGG	Straight Jack	174	25M2718	3.42
37-03M-TGG	Straight Jack	178	25M2719	3.42
37-02L-4-TGG	Right Angle Plug	174	25M2715	4.10
37-02M-5-TGG	Right Angle Plug	178	25M2716	3.23
37-04M-TGG	Straight Bulkhead Jack	178	25M2721	3.68

PCB CONNECTORS

37-05-TGG	Straight PCB Mount Plug	...	25M2722	2.89
37-06-TGG	Straight PCB Mount Jack	...	25M2723	2.71
37-07-1-TGG	RA PCB Mount Jack	...	25M2724	3.78

(116511)

RF COAX MICROMINIATURE

50-OHM MCX AND MMCX CONNECTORS

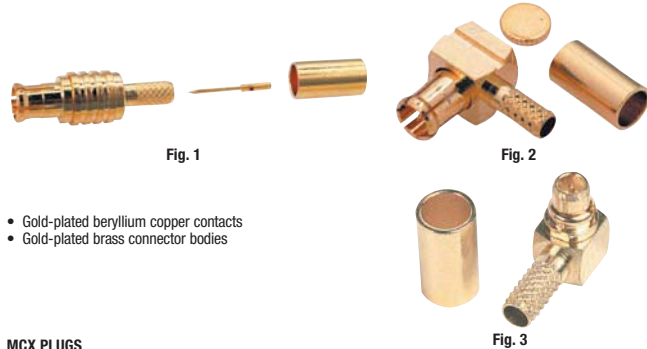

- Gold-plated beryllium copper contacts
- Gold-plated brass connector bodies

MCX PLUGS

Mfg. Part No.	Fig.	RG/U	Coaxial Termination	Connector Mounting	Stock No.	Price Each
● 27-01L-3 TGG	1	174, 188, 316	Crimp	Cable	25M2080	3.76
● 27-03L-9-TGG	2	174, 188, 316	Crimp	Cable	25M2083	5.80

MMCX PLUGS

● 37-02L-4-TGG	3	174	Crimp	Cable	25M2715	4.10
----------------	---	-----	-------	-------	---------	------

(114880)

50-OHM MMCX RF CONNECTORS (CONT.)

- Bandwidth up to 6 GHz
- Connectors allow rotation of 360°
- Non-slotted contact design
- Meets CECC 22340
- Gold-plated brass contacts (plugs)
- Gold-plated beryllium copper contacts (jacks)



RIGHT ANGLE JACK

Mfg. Part No.	Fig.	RG/U	Coaxial Termination	Connector Mounting	Stock No.	Price Each
● 73028	1	...	Solder	PC Board	77M7341	6.11

RIGHT ANGLE PLUG

● 73025	2	174, 316	Crimp	Cable	77M7339	6.43
● 73026	3	178	Crimp	Cable	77M7340	6.33
● 73032	4	402 Semi-Rigid	Crimp	Cable	77M7344	6.33
● 73033	5	405 Semi-Rigid	Crimp	Cable	77M7345	6.33

STRAIGHT JACK

● 73029	6	174, 316	Crimp	Cable	77M7342	5.23
● 73030	7	178	Crimp	Cable	77M7343	6.15
● 73037	8	405 Semi-Rigid	Crimp	Cable	77M7348	6.20
● 73039	9	...	Solder	PC Board	77M7350	5.92

STRAIGHT PLUG

● 73023	10	174, 316	Crimp	Cable	77M7337	6.95
● 73024	11	178	Crimp	Cable	77M7338	5.92
● 73034	12	402 Semi-Rigid	Crimp	Cable	77M7346	5.92
● 73035	13	405 Semi-Rigid	Crimp	Cable	77M7347	5.92
● 73038	14	...	Solder	PC Board	77M7349	8.73

(108518)

50-OHM MMCX RF CONNECTORS

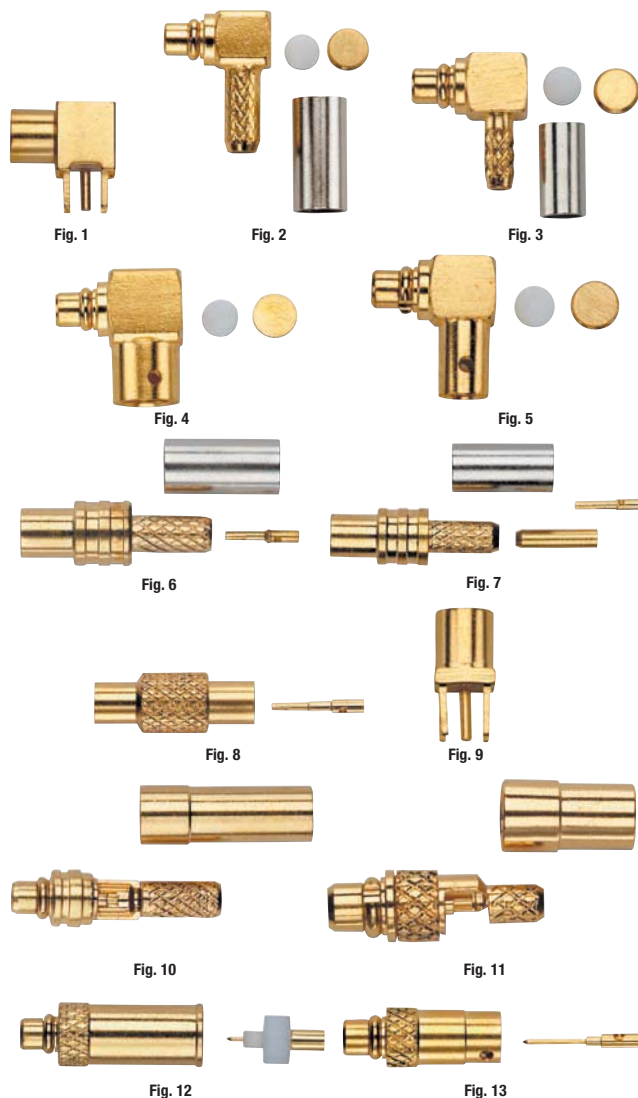

➤ CONTINUED ➤

50- AND 75-OHM MCX RF CONNECTORS

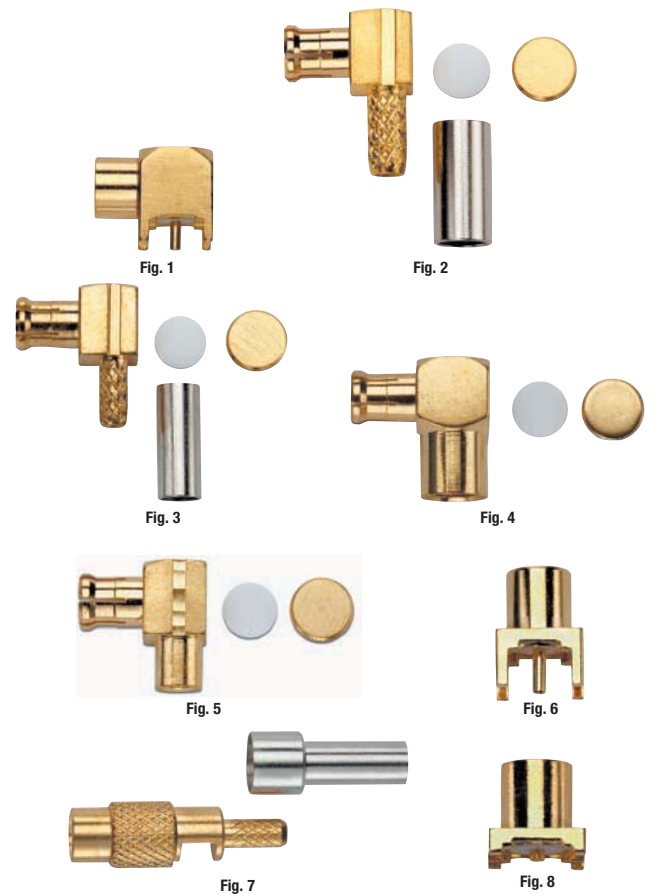

➤ CONTINUED ➤

RF COAX MICROMINIATURE • RF COAX ULTRAMINIATURE • RF COAX BLINDMATE

50- AND 75-OHM MCX RF CONNECTORS (CONT.)

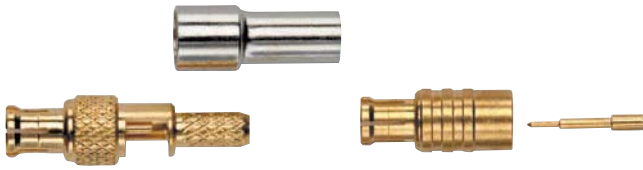

Fig. 9

Fig. 10

- Bandwidth up to 6 GHz
- Meets CECC 22220
- Gold-plated brass contacts (plugs)
- Gold-plated beryllium copper contacts (jacks)

RIGHT ANGLE JACK

Mfg. Part No.	Fig.	Impedance (Ohms)	RG/U	Coaxial Termination	Connector Mounting	Stock No.	Price Each
73008	1	50	...	Solder	PC Board	77M7328	4.38

RIGHT ANGLE PLUG

73005	2	50	174, 316	Crimp	Cable	77M7325	4.46
73006	3	50	178	Crimp	Cable	77M7326	4.67
73016	4	50	402 Semi-Rigid	Crimp	Cable	77M7334	4.83
73017	5	50	405 Semi-Rigid	Crimp	Cable	77M7335	4.75

STRAIGHT JACK

73007	6	50	...	Solder	PC Board	77M7327	3.55
73010	7	50	174, 316	Crimp	Cable	77M7329	4.33
73011	7	50	178	Crimp	Cable	77M7330	4.38
73012	7	75	179	Crimp	Cable	77M7331	5.16
73018	8	50	...	Solder	PC Board	77M7336	5.42

STRAIGHT PLUG

73002	9	50	174, 316	Crimp	Cable	77M7322	4.66
73003	9	50	178	Crimp	Cable	77M7323	4.20
73004	9	75	179	Crimp	Cable	77M7324	5.28
73014	10	50	402 Semi-Rigid	Crimp	Cable	77M7332	4.16
73015	10	50	405 Semi-Rigid	Crimp	Cable	77M7333	4.16

(108517)

50-OHM SNAP-ON INTERFACE COAXIAL CONNECTORS

Moebius interface is designed to be used as an antenna connection for handheld and mobile computing devices. The switching connector achieves high RF performance and extremely high durability (25,000 life cycles) and reliability while providing snap-on connection. Frequency range: DC to 6GHz.



Fig. 1

Fig. 2

JACKS

Mfg. Part No.	Fig.	Body Style	Connector Mounting	Coaxial Termination	RG/U	Stock No.	Price Each	
							1-24	25-49
R199006413	...	Straight	PC Board	Solder	...	10R6880	3.94	3.70
R199006813	1	Right Angle	PC Board	Solder	...	10R6881	4.73	4.44

PLUGS

R199006203	...	Straight	Cable	Crimp	178, 196	10R6876	5.50	5.16
R199006213	2	Right Angle	Cable	Crimp	178, 196	10R6877	6.16	5.78
R199006263	...	Straight	Cable	Crimp	188, 316	10R6878	5.50	5.16
R199006273	2	Right Angle	Cable	Crimp	188, 316	10R6879	6.16	5.78

(115551)

50-OHM ECO SERIES MMCX COAXIAL CONNECTORS

Just Added



- Frequency range: DC to 3GHz
- Snap-on mating
- Compliant to CECC and IEC standards
- Gold-plated brass connector body
- Insulator PTFE / Polypropylene
- Gold-plated beryllium copper female center contact
- Brass outer contact

JACKS

Mfg. Part No.	Body Style	Connector Mounting	Coaxial Termination	RG/U	Stock No.	Price Each
R110A422830	Straight	PC Board	Solder	...	11R6455	1.05
R110A426000	Straight	PC Board	Solder	...	11R6456	1.05
R110A427830	Straight	PC Board	Solder	...	11R6457	0.93

PLUGS

R110A170100	Right Angle	Cable	Crimp	178	11R6453	0.99
R110A172100	Right Angle	Cable	Crimp	174, 316	11R6454	0.99

(148765)

AMP UMCC DOUBLE ENDED CABLE ASSEMBLIES



- Applications:
- Wireless LAN, Mini PCI
 - Mobile Antenna/GPS/Radio Systems
 - PDA / PCS / Cellular Handset applications
 - Wireless Communications systems (LAN, GSM, PCS, WCDMA, UMTS)
 - Remote measuring equipment

Features:

- Ultra low profile (2.0mm or 2.5mm maximum mated height)
- Easy snap on/off mating
- Small footprint on PCB (3mm x 3mm)
- Excellent performance to 6 GHz
- 360 degree mated rotation

The UMCC series is an ultra low profile coax interconnect solution that meets the ever growing demand for miniaturization in next generation wireless applications. UMCC cable assemblies are available as double-ended jumpers and inter-series assemblies.

DOUBLE ENDED RIGHT ANGLE PLUG CABLE ASSEMBLIES

Mfg. Part No.	Length (mm)	Cable Dia. (mm)	UMCC Type	Mated Height	Cable Shielding	Stock No.	Price Each
2015698-2	100	0.81	II	2.0 mm	Single	96M0657	3.75
2015698-3	200	0.81	II	2.0 mm	Single	96M0658	4.00
2015699-1	100	0.81	III	2.5 mm	Single	96M0659	2.10
2015699-2	200	0.81	III	2.5 mm	Single	96M0660	4.08
2015487-4	100	1.13	III	2.5 mm	Single	96M0653	3.69
2015487-5	200	1.13	III	2.5 mm	Single	96M0654	4.04
2015700-1	100	1.32	III	2.5 mm	Double	96M0661	3.80
2015700-2	200	1.32	III	2.5 mm	Double	96M0662	3.78
2015357-4	200	1.37	III	2.5 mm	Double	96M0652	3.69
2015357-2	50	1.37	III	2.5 mm	Double	96M0651	4.04

INTERSERIES CABLE ASSEMBLIES

Mfg. Part No.	Description	Length (mm)	Stock No.	Price Each
2032439-1	UMCC R/A Plug to SMA Straight Plug	200	96M0663	22.31
2032440-1	UMCC R/A Plug to SMA Straight Bulkhead Jack	200	88M9368	21.67
2032441-1	UMCC R/A Plug to MCX Right Angle Plug	200	96M0664	23.28
2032443-1	UMCC R/A Plug to MMCX Right Angle Plug	200	96M0665	25.95

50-OHM RIGHT ANGLE JACK

Mfg. Part No.	Coaxial Termination	Connector Mounting	Contact Plating	Stock No.	Price Each		
					1-4	5-9	10-24
1566230-2	Solder	PC Board	Gold	96M0646	1.28	1.16	1.07
1775146-2	Solder	PC Board	Matte Tin	96M0647	0.90	0.83	0.77

STRAIGHT ADAPTER

Mfg. Part No.	Convert From	Convert To	Stock No.	Price Each		
				1-4	5-9	10-24
1775227-1	UMCC Jack	SMA Plug	96M0648	41.66	38.44	36.31
1775230-1	UMCC Plug	SMA Jack	96M0649	41.66	38.44	36.31

ACCESSORIES

Mfg. Part No.	Description	Stock No.	Price Each	
			1-4	5+
1775231-1	Extraction Tool	96M0650	3.03	2.06

(116502)

50-OHM MODULAR BLIND MATE COAXIAL CONNECTORS



Just Added

- Gold-plated beryllium copper contacts

OSP STRAIGHT JACKS

Mfg. Part No.	Connector Mounting	Coaxial Termination	RG/U	Stock No.	Price Each	
					1-99	100-249
1059506-1	Cable	Solder	405, 0.085" Semi-Rigid	10H7291	51.38	46.24
1059456-1	Panel	Solder	405, 0.085" Semi-Rigid	10H7289	25.56	23.01

▶ CONTINUED ▶

New products added weekly

(148898)

See the newest products, technologies and suppliers on our website.

RF COAX BLINDMATE • RF COAX MEDIUM

50-OHM MODULAR BLIND MATE COAXIAL CONNECTORS (CONT.)

OSP STRAIGHT PLUGS

Mfg. Part No.	Connector Mounting	Coaxial Termination	RG/U	Stock No.	Price Each	
					1-99	100-249
● 1059523-1	Cable	Crimp	174, 179, 187, 188, 316	08R5314	15.43	13.89
● 4503 7985 00	Cable	Solder	405, 0.085" Semi-Rigid	73C4059	19.37	17.44

OSP STRAIGHT PLUGS

● 1059919-1 (148679)	PC Board	Solder	...	08R5315	103.38	93.04
----------------------	----------	--------	-----	---------	--------	-------

50-OHM N CONNECTORS



• Gold-plated beryllium copper contacts

STRAIGHT JACK

Mfg. Part No.	Fig.	RG/U	Coaxial Termination	Connector Mounting	Stock No.	Price Each
● 1-5225664-2	1	58	Crimp	Cable	96M0581	22.88
● 1057116-1	...	402, 0.141" Semi-Rigid	Solder	Cable	10H7231	44.05
● 1057284-1	2	...	Solder	Panel	96M0601	16.65

TERMINATOR JACK

● 5227997-1	96M0671	27.13
-------------	-----	-----	-----	-----	---------	-------

STRAIGHT BULKHEAD JACK

● 1057140-1	...	174, 179, 187, 188, 316	Clamp	Panel	10J7831	35.74
● 1057151-1	...	401, 0.25" Semi-Rigid	Clamp	Panel	10H7233	139.73
● 228658-1	3	402, 0.141" Semi-Rigid	Crimp	Panel	91B8049	54.63

RIGHT ANGLE JACK

● 5225669-2	...	213	Crimp	Cable	58M2957	38.88
-------------	-----	-----	-------	-------	---------	-------

STRAIGHT PLUG

● 1-5225661-3	4	55, 223	Crimp	Cable	96M0580	12.40
● 5225392-7	4	58	Crimp	Cable	96M0667	20.98
● 1057243-1	4	58, 141, 303	Crimp	Cable	96M0599	28.03
● 5225361-4	4	142	Crimp	Cable	96M0666	18.35
● 5225661-2	4	213	Crimp	Cable	96M0668	14.23
● 5225699-1	4	213	Crimp	Cable	04M4930	19.90
● 1-5225092-1	4	393	Crimp	Cable	96M0579	30.00
● 228440-1	4	402, 0.141" Semi-Rigid	Crimp	Cable	20C0004	44.38
● 6274532-1	5	LMR240	Crimp	Cable	96M0691	5.63
● 1057094-1	...	405, 0.085" Semi-Rigid	Solder	Cable	01E9234	38.48
● 1057279-1	Solder	Panel	96M0600	21.20

STRAIGHT ADAPTER

Mfg. Part No.	Fig.	Convert From	Convert To	Stock No.	Price Each	
					1-24	25-49
● 1057374-1 (112560)	...	OSN Jack	OSN Plug	67H6108	192.33	

AMP 50-OHM N CONNECTORS



Fully interchangeable with MIL-C-39012 connectors. Order hand tools separately on page 1039. See Product Index for complete selection of coaxial cable.

DUAL CRIMP N PLUGS

Mfg. Part No.	RG/U	Plating Center Contact/Body	Dim. L	Stock No.	Price Each	
					1-24	25-49
● 1-5225661-6*	Belden 8214	Gold/Nickel	1.687"	16M2668	14.23	12.24
● 1-5225661-2*	58, 58A, 58B, 58C	Gold/Nickel	1.687"	16M2667	14.47	13.62
● 5225361-1*†	...	Gold/Silver	1.687"	16M3221	21.05	18.11

CONTINUED

AMP 50-OHM N CONNECTORS (CONT.)

Mfg. Part No.	RG/U	Plating Center Contact/Body	Dim. L	Stock No.	Price Each	
● 5225392-1*†	55, 55U, 223, 223U	Gold/Silver	1.687"	16M3222	15.22	14.31
● 5225392-2*†	142B/U, 142/U, 142A/U	Gold/Silver	1.687"	16M3223	20.98	18.04
● 1-5227086-0+	8, 8A, 213	Gold/Nickel	1.687"	16M2670	8.73	7.51
● 5225662-2*†	...	Gold/Nickel	1.859"	16M3235	16.00	13.76
● 5225661-1*†	9, 9A, 9B, 214	Gold/Nickel	1.859"	16M3234	14.23	12.24
● 1-5225554-1*†	393	Gold/Silver	2.500"	16M3858	47.48	40.83
● 1057088-1*†	402 Semi-Rigid/3.58	Gold/Nickel	0.968"	94C2715	28.42	25.84

DUAL CRIMP N JACKS

● 5225664-2*†	8, 8A, 213	Gold/Nickel	1.937"	16M3236	26.35	22.67
---------------	------------	-------------	--------	---------	-------	-------

FLANGE MOUNT N JACKS

● 1057176-1	402/U	Gold/Passivated	1.000"	73M8552	45.76	41.18
● 1058644-1+	...	Gold/Passivated	1.441"	73M8553	37.95	32.64
● 1057290-1*	...	Gold/Nickel	1.441"	48F5702	16.95	14.58

* MIL Style; + Commercial-Grade Style; • Bulkhead; † Weatherproof (8243)

N WEATHERPROOF COAXIAL CONNECTORS



Threaded coupling devices designed for use up to microwave frequencies. 0-11GHz, VSWR consistently low. Impedance: 50 ohm. Dielectric withstanding: 2500Vrms.

STRAIGHT PLUGS

Mfg. Part No.	Fig.	MIL No.	Termination	RG/U	Stock No.	Price Each
● 82-61 (UG-21B/U)	1	UG-21B/U	Clamp/Solder	8, 9, 213, 214	59K0528	24.20
● 82-96 (UG-21C/U)	1	UG-21C/U	Clamp/Solder	8, 9, 213, 214, 225	59K0532	18.06
● 82-202 (UG-21D/U)	1	UG-21D/U	Clamp/Solder	8, 9, 213, 225	59K0523	16.97
● 82-312 (UG-1185/U)	1	UG-1185/U	Clamp/Solder	8, 9, 213, 225	59K0525	15.17
● 34000(UG-536/U)	1	UG-536/U	Clamp/Solder	58, 141, 142A, 400, Amphenol TWB 5800	39F1323	81.08
● 34025 (UG-536B/U)	1	UG-536B/U	Clamp/Solder	89907, 37806A, 141, 58	39F1324	10.92
● 82-202-1006	1	...	Clamp/Solder	Belden 9913, LMR400	94F661	8.22
● 82-6034	1	...	Crimp/Crimp	174, 188A	01F685	7.18
● 82-340	2	01B0007	Crimp	8, 9, 213, 225	55M2614	12.82
● 82-340-1052	2	...	Crimp	Belden 9913, LMR400	73K1484	9.60
● 82-5370	2	...	Crimp	142, 400	51F3794	10.16
● 82-5375	2	...	Crimp	89907, B7806A, 141, 58	51F3796	8.61
82-332 (01-0008)	2	01B0008	Crimp	8, 9, 213, 225	39F195	13.55
● 82-4425	2	01-0501+	Crimp	8, 9, 213, 225	82K8900	13.96
82-4426	2	01-0502+	Crimp	8, 9, 213, 225	51F3805	17.70
● 82-4427	2	01-0503+	Crimp	142, 400	77B6873	13.62
● 82-6152	2	...	Crimp	Belden 9258, 8X	19C5174	4.99
● 82-340-1054	2	...	Crimp	LMR 400	73K1485	17.61
● 82-4352	...	M39012/01-0005	Crimp/Solder	8, 9, 213, 225	19C5139	18.97
● 82-209-1006	Clamp/Solder	LMR400, Belden 7810A, 8214, 9913	73K1483	12.21
● 49000	Solder	8, 58, 141, 225	50F1600	24.10
● 82-63 (UG-23B/U)	3	UG-23B/U	Crimp	8, 9, 87A, 144, 165, 213, 214, 216, 225	59K0529	14.38
● 82-6313	Crimp	59, 162, 140, 210, Belden 8241, 8263, 8279, 9209	42J6001	9.94

RIGHT-ANGLE PLUGS

82-4440	...	05-0501+	Crimp	8, 9, 213, 225	90F8480	44.15
● 82-5374	Crimp	142, 400	50F2454	51.37
82-4442	...	M39012/05-0503	Crimp/Solder	142, 400	83C5679	61.19

CONTINUED

N WEATHERPROOF COAXIAL CONNECTORS (CONT.)

STRAIGHT BULKHEAD JACKS

Mfg. Part No.	Fig.	MIL No.	Termination	RG/U	Stock No.	Price Each			
						1-9	10-24	25-99	100-499
82-5378	Crimp	89907, B7806A, 141, 58	93F1529	26.31			
82-5373	Crimp	55, 142, 233, 400	50F2455	12.37			
35275	...	UG-556B/U	Clamp/Solder	55, 58, 141, 142, 223	73K1453	93.03			

BULKHEAD RECEPTACLE

82-811 (UG-680/U)	...	UG-680/U	Clamp/Solder	...	39F1128	75.34			
-------------------	-----	----------	--------------	-----	---------	-------	--	--	--

4-HOLE FLANGE PANEL JACKS

82-62	...	UG-23B/U	Clamp/Solder	...	39F020	20.35			
82-5372	Crimp	142, 400	98F3519	17.19			
82-24 (UG-58/U)	...	UG-58/U	59K0524	11.53			
82-97 (UG-58A/U)	...	UG-58A/U	Solder	...	39F028	12.92			

+Section of MIL-SPEC 39012

ADAPTERS

Mfg. Part No.	Fig.	Description	Stock No.	Price Each			
				1-9	10-24	25-99	100-499
82-66 (UG-30/U)	...	Bulkhead Adapter, J-J	39F022	23.69			
91100 (UG-30D/U)	...	Bulkhead Adapter, J-J	82K8914	100.50			
82-100 (UG-57B/U)	4	Straight Adapter, P-P	39F1111	14.87			
82-101 (UG-29B/U)	5	Straight Adapter, J-J	39F1112	18.40			
82-64 (UG-27A/U)	6	Right Angle Adapter, J-P	59K0530	30.51			
82-213 (UG-27C/U)	6	Right Angle Adapter, J-P	60K7160	31.31			
82-98 (UG-27B/U)	6	Right Angle Adapter, J-P	59K0533	33.67			
82-65 (UG-29A/U)	...	Right Angle Adapter, P-J	82K8903	16.29			
82-102 (UG-107B/U)	...	Tee Adapter, J-P-J	39F078	127.91			

TYPE N MALE CAP RESISTOR

Terminated; rated 50-ohm, 5% 1 watt.

Mfg. Part No.	Description	Stock No.	Price Each	
			1-9	10-24
82-5722-RFX	Cap Resistor	93F1462	6.26	
82-106	Male Cap	19C5129	18.84	
6950	Type N Female Cap and Chain	83C3570	34.68	

(8199)

RFX™ TYPE N COAXIAL CONNECTORS



Amphenol® RF
Global RF Solutions

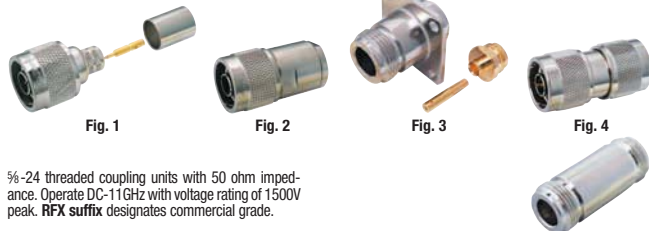

%-24 threaded coupling units with 50 ohm impedance. Operate DC-11GHz with voltage rating of 1500V peak. RFX suffix designates commercial grade.

RFX™ TYPE N CABLE PLUGS—MALE CONTACTS

Mfg. Part No.	Fig.	RG/U	Stock No.	Price Each			
				1-9	10-24	25-99	100-499
82-4426-11RFX	1	Belden 9880, 89880, Times AA4478, AA4479	93F1455	5.65	5.16	4.75	4.40
82-202-RFX	2	8, 9, 87A, 213, 214, 225	93F1454	5.63	5.15	4.39	4.09
82-5375-RFX	1	58, 58C, 141, 89907, B7806A	93F7583	4.22	3.58	3.27	3.02
82-5380-RFX	1	59, 62, 140, 210	19C5148	4.54	4.14	3.81	3.53
82-5955-RFX	...	402, 0.141" Semi-Rigid	19C5153	5.30	4.84	4.46	4.14
34025-RFX	2	58, 58A, 58C, 141, 303, LMR195	93F1390	5.47	4.83	4.49	4.22

RFX™ TYPE N CABLE JACKS—FEMALE CONTACTS

82-6099-RFX	3	402, 0.141" Semi-Rigid	19C5166	8.53	7.75	7.11	6.56
82-5378-RFX	...	58, 58A, 58C, 141, 303, LMR195	19C5147	4.90	4.46	4.08	3.78
82-6097-RFX	...	402, 0.141" Semi-Rigid	19C5164	7.55	6.89	6.35	5.80

RFX™ TYPE N PANEL RECEPTACLE (FRONT OR REAR MOUNT)

Mfg. Part No.	Fig.	Description	Stock No.	Price Each			
				1-9	10-24	25-99	100-499
82-97-RFX	3	4-Hole Panel	93F1450	4.64	3.87	3.57	3.32
82-6101-RFX	...	4-Hole Flange Panel	19C5168	4.54	4.14	3.81	3.53

➔ CONTINUED ➔

RFX™ TYPE N COAXIAL CONNECTORS (CONT.)

RFX™ TYPE N ADAPTERS

Mfg. Part No.	Fig.	Description	Stock No.	Price Each			
				1-9	10-24	25-99	100-499
82-100-RFX	4	Straight, Plug-Plug	93F1451	7.41	6.73	5.56	5.29
82-101-RFX	5	Straight, Jack-Jack	93F1452	4.62	4.20	3.85	3.55
82-66-RFX	...	Bulkhead, Jack-Jack	31C7129	5.09	4.65	4.28	3.97

RFX™ TYPE N ANGLE ADAPTERS

Mfg. Part No.	Fig.	Description	Stock No.	Price Each			
				1-9	10-24	25-99	100-499
82-64-RFX	...	Right Angle, Jack-Plug	13C3104	12.11	11.06	10.19	9.45

(8274)

N CONNECTORS FOR LMR 100-600 CABLE



Amphenol Connex



Connector bodies are nickel-plated, contacts are 30µm gold-plated and insulators are Teflon®.

Mfg. Part No.	Description	Cable	Stock No.	Price Each	
				1-9	10-24
172135	N Plug	LMR 240 Rev Pol.	92C6726	4.20	3.84
172219	N Right-Angle Plug	LMR 240, 8X	92C6744	6.84	6.23
172148	N Straight Jack	LMR 240, 8X	92C6727	3.95	3.62
172149	N Bulkhead Jack	LMR 240, 8X	92C6728	6.25	5.67
172304	N Plug	LMR 300	92C6753	4.41	4.04
172102H243	N Plug	LMR 400, B9913	92C6718	3.80	3.45
172102H243RP	N Plug	LMR 400 Rev Pol.	92C6719	6.51	5.95
172176	N Right-Angle Plug	LMR 400, B9913	92C6729	9.37	8.50
172203	N Straight Jack	LMR 400, B9913	92C6732	4.00	3.61
172220	N Bulkhead Jack	LMR 400, B9913	92C6745	6.57	6.01
172206	N Plug	LMR 600	92C6735	12.63	11.55
172263	N Right-Angle Plug	LMR 600	92C6748	11.14	10.18
172207	N Straight Jack	LMR 600	92C6737	11.51	10.51
172128	N Plug	LMR 100, 316/U	92C6722	5.26	4.82
172180	N Right-Angle Plug	LMR 100, 316/U	92C6731	8.80	7.95
172204	N Straight Jack	LMR 100, 316/U	92C6734	5.61	5.14
172129	N Bulkhead Jack	LMR 100, 316/U	92C6724	5.48	4.98
172100	N Plug	LMR 195, 58/U	92C6716	4.15	3.78
172100RP	N Plug	LMR 195, 58/U Rev Pol.	92C6717	6.20	5.65
172177	N Right-Angle Plug	LMR 195, 58/U	92C6730	8.51	7.78
172103	N Straight Jack	LMR 195, 58/U	92C6720	4.05	3.71
172214	N Plug	LMR 200	92C6741	3.94	3.62
172177	N Right-Angle Plug	LMR 200	92C6730	8.51	7.78

(73113)

V-BITE® PC EDGE MOUNT N COAXIAL CONNECTORS

Just Added



- Low profile, 0.270" high FMS
- Anti-rotational
- VSWR 1.15:1
- Patented V-Bite® snaps into PC board
- Surface mount center contact
- TFE insulator



N TYPE EDGE MOUNT JACK

Mfg. Part No.	Fig.	Impedance (Ω)	Contact Material	Contact Plating	Features	Price Each		
						Stock No.	1-24	25-49
161V504E	1	50	Brass	Gold	...	12M4398	12.61	11.40
161V504EFT	2	50	Brass	Gold	Flanged	27M1255	19.03	17.21

(142224)

Designing an embedded control system?
See our huge selection of MCUs, MPUs & DSPs in this catalog and online.

(148861)

RF COAX MEDIUM

50-OHM TYPE N CONNECTORS

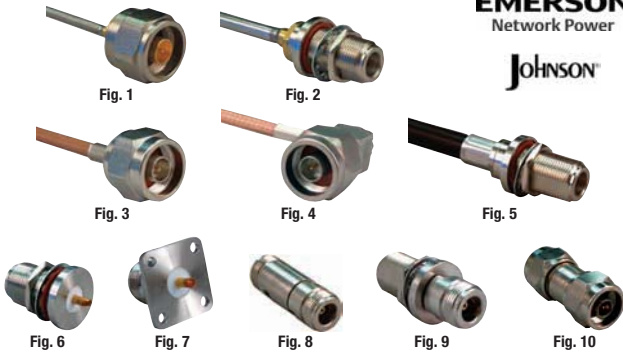

- Meet MIL-PRF-39012 performance requirements
- Designs are based on 50Ω system impedance per MIL-STD-348
- Operate at frequencies up to 11GHz min.

Body material: brass. Contact material: brass (plugs), beryllium copper (jacks and adapters). Contact finish: gold.

STRAIGHT SOLDER PLUGS — SOLDER CONTACT

Mfg. Part No.	Fig.	Body Plating	RG Cable Type	Stock No.	Price Each	
					1-9	10-49
● 138-4693-001	1	Gold	405, 0.085" Semi-Rigid	06M3386	21.08	19.57
● 138-4694-001	1	Gold	402, 0.141" Semi-Rigid	06M3388	18.07	16.78
● 138-4696-001	1	Gold	401, 0.25" Semi-Rigid	06M3390	21.41	19.88

STRAIGHT SOLDER PLUGS — CAPTIVATED SOLDERLESS CONTACT

● 138-4693-011	1	Gold	405, 0.085" Semi-Rigid	06M3387	22.25	20.66
● 138-4694-011	1	Gold	402, 0.141" Semi-Rigid	06M3389	22.33	20.73
● 138-4696-011	1	Gold	401, 0.25" Semi-Rigid	06M3391	21.16	19.65

STRAIGHT SOLDER BULKHEAD JACKS — SOLDER CONTACT

● 138-4596-401	2	Gold	401, 0.25" Semi-Rigid	06M3385	22.99	21.35
● 138-4594-401	2	Gold	402, 0.141" Semi-Rigid	06M3384	18.00	16.72
● 138-4593-401	2	Gold	401, 0.25" Semi-Rigid	06M3383	22.99	21.35

STRAIGHT CRIMP PLUGS — SOLDER OR CRIMP CONTACT

● 138-4403-007	3	Copper/Tin/Zinc	161, 174, 188, 316	06M3370	15.71	14.59
● 138-4404-007	3	Copper/Tin/Zinc	188DS, 316DS	06M3372	20.66	19.19
● 138-4407-007	3	Copper/Tin/Zinc	58, 141, 303	06M3374	12.31	11.43
● 138-4408-007	3	Copper/Tin/Zinc	55, 142, 223, 400	06M3376	12.31	11.43
● 138-4416-007	3	Copper/Tin/Zinc	8, 213	06M3378	17.33	16.09
● 138-4418-007	3	Copper/Tin/Zinc	9, 214	06M3380	17.00	15.78
● 138-4449-007	3	Copper/Tin/Zinc	8, LMR400	06M3382	16.66	15.47

RIGHT ANGLE CRIMP PLUGS — CAPTIVATED CONTACT

● 138-4403-107	4	Copper/Tin/Zinc	161, 174, 188, 316	06M3371	25.33	23.52
● 138-4404-107	4	Copper/Tin/Zinc	188DS, 316DS	06M3373	25.99	24.14
● 138-4407-107	4	Copper/Tin/Zinc	58, 141, 303	06M3375	22.57	20.95
● 138-4408-107	4	Copper/Tin/Zinc	55, 142, 223, 400	06M3377	26.33	24.45
● 138-4416-107	4	Copper/Tin/Zinc	8, 213	06M3379	27.49	25.53
● 138-4418-107	4	Copper/Tin/Zinc	9, 214	06M3381	27.49	25.53

STRAIGHT CRIMP BULKHEAD JACKS — SOLDER OR CRIMP CONTACT

● 138-4303-407	5	Copper/Tin/Zinc	161, 174, 188, 316	06M3363	20.69	19.21
● 138-4304-407	5	Copper/Tin/Zinc	188DS, 316DS	06M3364	26.33	24.45
● 138-4307-407	5	Copper/Tin/Zinc	58, 141, 303	06M3365	22.07	20.49
● 138-4308-407	5	Copper/Tin/Zinc	55, 142, 223, 400	06M3366	25.74	23.91
● 138-4316-407	5	Copper/Tin/Zinc	8, 213	06M3367	25.41	23.60
● 138-4318-407	5	Copper/Tin/Zinc	9, 214	06M3368	25.83	23.98
● 138-4349-407	5	Copper/Tin/Zinc	8, LMR400	06M3369	22.35	20.76

REAR MOUNT BULKHEAD JACKS

Mfg. Part No.	Fig.	Body Plating	Panel Thickness (in.)	Stock No.	Price Each		
					1-9	10-49	50-99
● 138-4701-407	6	Copper/Tin/Zinc	0.125	06M3392	31.66	29.40	26.34

4-HOLE FLANGE MOUNT JACK — FLUSH DIELECTRIC

Mfg. Part No.	Fig.	Body Plating	Tail Length (in.)	Stock No.	Price Each		
					1-9	10-49	50-99
● 138-4701-607	7	Copper/Tin/Zinc	0.250	06M3393	31.66	29.40	26.34

ADAPTERS

Mfg. Part No.	Fig.	Convert From	Convert To	Stock No.	Price Each		
					1-9	10-49	50-99
● 138-4901-807	8	N Jack	N Jack	06M3395	36.85	34.21	30.65
● 138-4901-407	9	N Jack	N Jack	06M3394	35.41	32.88	29.46
● 138-4901-817	10	N Plug	N Plug	06M3396	42.15	39.14	35.07

(89362)

N STYLE STRAIGHT COAXIAL RF PLUGS



Mfg. Part No.	Cable Type	Gender	Mil. No. 39012/	Stock No.	Price Each
					1-499
● KN-39-83	9, 9A, 9B, 214, 225, 393	Plug	...	17B5395	28.48
● KN-59-176	8, 9, 213, 214	Plug	01-0005	90F1971	18.08
● KN-59-239	9, 9A, 9B, 214, 225, 393	Plug	01-0501	90F1973	15.02
● KN-59-242	142, 223, 400	Plug	01-0503	90F1974	18.21
● UG-536B/U	55, 88, 141, 400	Plug	...	44F8438	33.06
● UG-536C/U	58, 58A, 58C, 141, 141A	Plug	...	90F1980	33.63
● UG-1095 B/U	58, 142, 223	Female	...	17B5414	32.19

ADAPTERS

Mfg. Part No.	Description	Mil. No. 39012/	Stock No.	Price Each
				1-499
● UG-201A/U	N Plug to BNC Jack		44F8447	22.42

ACCESSORIES

Mfg. Part No.	Description	Mil. No. 39012/	Stock No.	Price Each
				1-499
● KN-89-30	Cap and Chain	25-0011	90F1979	8.86

VOLTREX® BRAND N CONNECTORS



50-ohm N connectors feature Teflon® insulation. Mfg. part nos. with (*) have brass contacts and offer a voltage rating of 500V RMS and a frequency rating of 0-11GHz. Mfg. part nos. with (+) have gold contacts and offer a voltage rating of 1000V RMS and a frequency rating of 0-3GHz.

CRIMP PLUGS

Mfg. Part No.	Fig.	RG/U	Jacket O.D.	Stock No.	Price Each	
					1-49	50-99
● CPN-8*	1	8, 213	0.400-0.410"	87N817	10.68	8.76
● SPC4266+	1	8	0.400-0.410"	84N1255	11.44	9.41
● CPN-58*	1	58	0.185-0.205"	87N818	8.17	6.70
● SPC4265+	1	58	0.185-0.205"	84N1254	10.68	8.78
● SPC19884*	1	142	0.200-0.220"	83K0859	7.05	5.78
● SPC19885±*	1	142	...	83K0860	9.66	7.91
● SPC19886*	1	8	0.400-0.410"	83K0861	7.05	5.78
● SPC19887*	1	450	0.220-0.250"	83K0862	10.68	8.76
● SPC19888*	1	8X	0.220-0.250"	83K0863	10.68	8.76
● SPC19889*	1	8	...	83K0864	5.19	4.82
● 11-11-4 UTSS*	1	58	...	03M5859	4.11	3.38
● MC23542	...	142	...	96M8826	4.38	3.59
● MC23543	1	Belden 9913	...	96M8827	5.00	4.10
● MC23568	1	213	...	96M8852	5.00	4.10
● SPC21086	1	213	...	10M8337	6.58	5.40

CRIMP JACKS

● CPN-59††	83K0865	11.54	9.46
● 1550+†	...	58	0.185-0.205"	92N3396	4.41	4.01
● SPC4346+	3	58	0.185-0.205"	84N1270	10.27	8.41

CLAMP PLUGS

● 1548+	4	58	0.185-0.205"	92N3394	4.33	...
● SPC4267+‡	4	58	0.185-0.205"	84N1256	14.35	11.80
● SPC4277+	5	Belden 9913	0.340-0.350"	84N1266	16.00	13.16
● 11-01B-17 TSS*	6	UR67	...	25M0281	6.31	5.19

➤ CONTINUED ➤

VOLTREX® BRAND N CONNECTORS (CONT.)

CLAMP JACKS

Mfg. Part No.	Fig.	RG/U	Jacket O.D.	Stock No.	Price Each	
					1-49	50-99
● SPC4344+	7	Belden 9913	...	84N1268	14.65	12.04
● SPC4345+	8	58	0.185-0.205"	84N1269	12.28	10.10
● 11-02-B-3 TSS*	7	UR67	...	25M0282	5.75	4.73

SOLDER JACKS

● MC23558	2	96M8842	2.60	2.26
-----------	---	-----	-----	-------------------------	------	------

*Female 4-Hole Flange; †Solder (18028)

50Ω N COAXIAL CONNECTORS



Pomona®

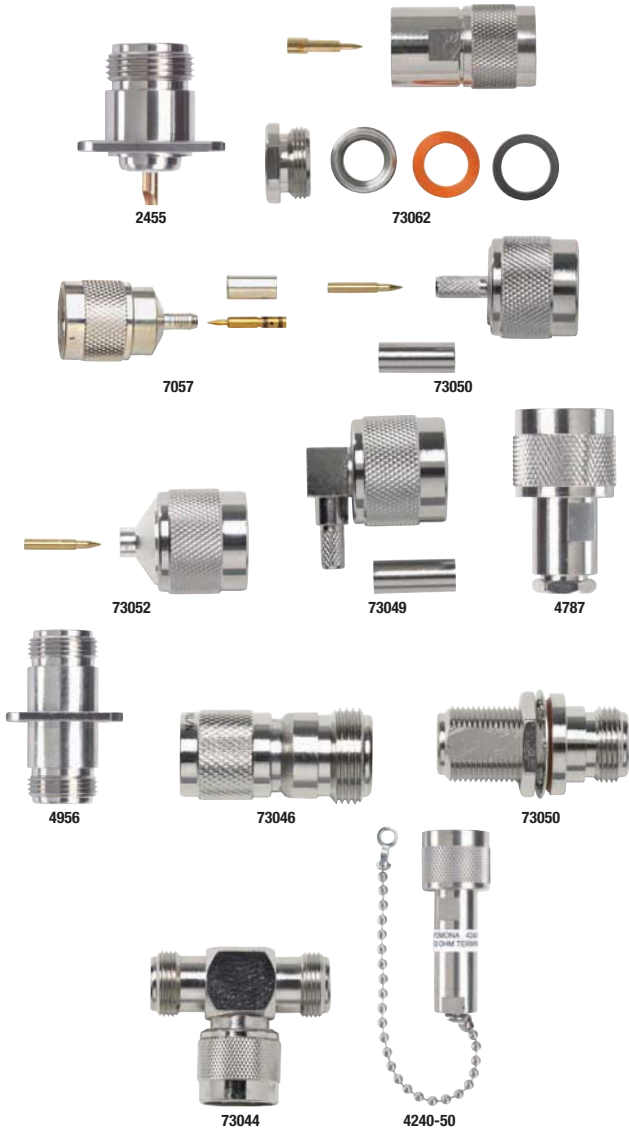

STRAIGHT JACKS

Mfg. Part No.	Connector Mounting	Coaxial Termination	RG/U	Stock No.	Price Each	
					1-24	25-49
● 2455	Panel	Solder	...	77B2254	7.98	7.43

STRAIGHT PLUGS

73051	Cable	Clamp	8, 213	08R6356	7.26	...
73062	Cable	Clamp	8, 9, 144, 165, 213, 214, 216, 225	08R6365	12.20	...
● 7057	Cable	Crimp	55, 142, 223, 400	23J7888	9.31	8.68
73050	Cable	Crimp	58, 141	08R6355	7.13	...
● 4787	Cable	Crimp	58, 141, 142, 223	77B2729	12.75	11.88
73052	Cable	Crimp	402, 0.141" Semi-Rigid	08R6357	6.79	...

▶ CONTINUED ▶

50Ω N COAXIAL CONNECTORS (CONT.)

RIGHT ANGLE PLUGS

Mfg. Part No.	Connector Mounting	Coaxial Termination	RG/U	Stock No.	Price Each	
					1-24	25-49
73048	Cable	Clamp	214, 225, 393	08R6353	7.78	...
73049	Cable	Crimp	55, 142, 223	08R6354	7.66	...

ADAPTERS

Mfg. Part No.	Body Style	Convert From	Convert To	Stock No.	Price Each	
					1-24	25-49
● 3288	Straight	BNC Jack	N Plug	39F3632	10.86	10.12
● 3841	Straight	N Jack	N Jack	44F5332	12.75	11.88
● 3842	Straight	N Plug	N Plug	50F1475	13.31	12.40
● 3535	Straight	BNC Plug	N Plug	89F364	14.63	13.63
● 4956	Straight	N Jack	N Jack	46F2209	27.18	25.33
73046	Straight	N Jack	TNC Plug	08R6351	10.21	...
73047	Straight	N Jack	UHF Plug	08R6352	10.90	...
73045	Straight Bulkhead	N Jack	N Jack	08R6350	9.81	...
● 3843	Right Angle	N Plug	N Jack	77B2419	29.91	27.87
● 5089	Tee	N Jack	N Jack Jack	78B1869	63.11	58.81
73044	Tee	N Jack	N Plug Jack	08R6349	15.36	...

TERMINATORS

● 4240-50	Straight	77B2471	68.56	63.88
-----------	----------	-----	-----	-------------------------	-------	-------

HN MEDIUM-SIZE WEATHERPROOF COAXIAL CONNECTORS



Amphenol® RF
Global RF Solutions

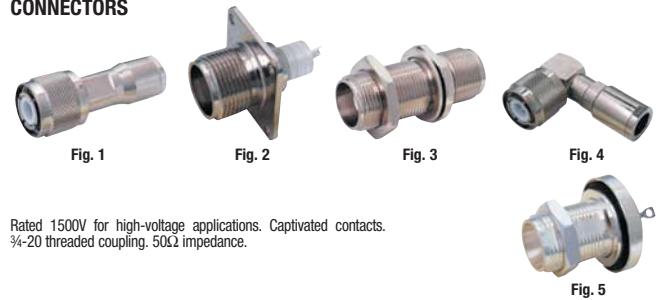

Rated 1500V for high-voltage applications. Captivated contacts. 3/4-20 threaded coupling. 50Ω impedance.

Mfg. Part No.	Fig.	MIL No.	Description	RG/U	Stock No.	Price Each
						1-9
● 82-804	1	UG-59B/U	Straight Plug	8,9,87,213,214,225	39F026	53.05
● 82-816-1000	1	...	Straight Plug	108A	91B2859	132.83
● 82-92	2	UG-496/U	Panel Receptacle	...	82K8905	42.21
● 82-805	2	UG-560	Panel Receptacle	...	59K0531	55.05
● 11050	3	...	Bulkhead Adapter J-J	...	51F3811	113.89
● 82-856	4	...	Right-Angle Plug	8,9,87A,213,214,225	73K1490	94.46
● 82-843	5	...	Bulkhead Receptacle, Rear Mount, Spade Terminal	...	73K1489	212.23
● 16750	1	...	Straight Plug	58,141,142	59K0312	151.94

50-OHM F & G CONNECTORS



Tyco Electronics

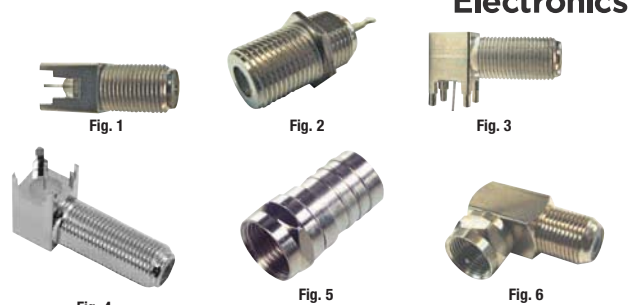

▶ CONTINUED ▶

RF COAX MEDIUM

50-OHM F & G CONNECTORS (CONT.)

F STRAIGHT JACK

Mfg. Part No.	Fig.	RG/U	Coaxial Termination	Connector Mounting	Stock No.	Price Each	
						1-24	25-49
5887046-1	1	...	Solder	PC Board	77M9223	4.44	

F STRAIGHT BULKHEAD JACK

5415712-1	2	179	Crimp	Panel	96M0681	39.00	
6274020-1	Solder	PC Board	96M0687	3.93	

F RIGHT ANGLE JACK

Mfg. Part No.	Fig.	Connector Length (mm)	Coaxial Termination	Connector Mounting	Stock No.	Price Each	
						1-24	25-49
5415302-1	3	25.4	Solder	PC Board	26M7996	5.64	
5415302-3	3	25.4	Solder	PC Board	96M0677	1.86	
5415476-1	3	26.26	Solder	PC Board	96M0680	1.86	
5415302-2	3	31.75	Solder	PC Board	96M0676	1.86	
5415276-2	3	33.8	Solder	PC Board	96M0675	2.01	
5887078-1	4	29.97	Solder	PC Board	96M0683	2.01	
5415024-1	4	35.61	Solder	PC Board	96M0674	3.33	
6274430-1	...	34.77	Solder	PC Board	96M0689	2.29	
5415322-2	...	35.69	Solder	PC Board	96M0678	4.50	

F STRAIGHT PLUG

Mfg. Part No.	Fig.	RG/U	Coaxial Termination	Connector Mounting	Stock No.	Price Each	
						1-24	25-49
414766-8	5	59	Crimp	Cable	96B5212	0.86	

F RIGHT ANGLE PLUG

887098-1	...	6	Crimp	Cable	85C0948	6.66	
----------	-----	---	-------	-------	---------	------	--

G RIGHT ANGLE PLUG

5415406-2	Solder	PC Board	96M0679	5.40	
-----------	-----	-----	--------	----------	---------	------	--

STRAIGHT ADAPTER

Mfg. Part No.	Fig.	Convert From	Convert To	Stock No.	Price Each	
					1-24	25-49
5887089-1	6	F Jack	F Plug	40M7815	5.64	

(114907)

50- AND 75-OHM ZDC SERIES F CONNECTORS AND ADAPTERS

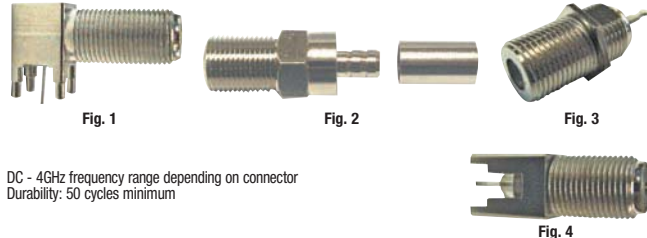

DC - 4GHz frequency range depending on connector
Durability: 50 cycles minimum

RIGHT ANGLE JACK (TIN/COPPER-PLATED PHOSPHOR BRONZE CONTACTS)

Mfg. Part No.	Fig.	Impedance (Ohms)	RG/U	Connector Mounting	Coaxial Termination	Stock No.	Price Each	
							1-49	50-99
5-1634540-1	1	75	...	PC Board	Solder	78M7241	1.33	
5-1634552-1	1	75	...	PC Board	Solder	78M7242	1.37	

STRAIGHT BULKHEAD JACK (TIN-PLATED BRASS CONTACTS)

5-1814826-1	2	75	59, 62, 140, 210	Cable	Crimp	78M7268	2.38	
5-1814826-3	2	75	6	Cable	Crimp	78M7269	2.38	

STRAIGHT BULKHEAD JACK (TIN-PLATED PHOSPHOR BRONZE CONTACTS)

5-1814823-1	3	75	...	Bulkhead	Solder	78M7266	0.83	
-------------	---	----	-----	----------	--------	---------	------	--

STRAIGHT JACK (TIN-PLATED PHOSPHOR BRONZE CONTACTS)

5-1814825-1	4	75	...	PC Board	Solder	78M7267	1.33	
-------------	---	----	-----	----------	--------	---------	------	--

STRAIGHT PLUG

5-1814821-7	...	75	CT125	Cable	Crimp	78M7261	0.83	
5-1814821-1	...	75	59, 62, 140, 210	Cable	Crimp	78M7259	0.79	
5-1814821-3	...	75	6	Cable	Crimp	78M7260	0.79	
5-1814822-5	...	75	CT100	Cable	Twist On	78M7264	0.64	
5-1814822-7	...	75	CT125	Cable	Twist On	78M7265	0.66	
5-1814822-1	...	75	59, 62, 140, 210	Cable	Twist On	78M7262	0.62	
5-1814822-3	...	75	6	Cable	Twist On	78M7263	0.60	

RIGHT ANGLE ADAPTER

Mfg. Part No.	Impedance (Ohms)	Convert From	Convert To	Stock No.	Price Each	
					1-49	50-99
5-1634537-1	50	F Jack	F Plug	78M7240	2.85	2.52

(108525)

V-BITE® PC EDGE MOUNT F COAXIAL CONNECTORS



- Low profile, 0.270" high FMS
- Anti-rotational
- VSWR 1.15:1
- Patented V-Bite® snaps into PC board
- Surface mount center contact



F TYPE EDGE MOUNT JACK

Mfg. Part No.	Fig.	Contact Material	Contact Finish	RG Cable Type	Stock No.	Price Each	
						1-24	25-49
861V509E	4	Phosphor Bronze	Gold	59	80K0627	3.67	3.32

F TYPE EDGE MOUNT JACKS WITH TEFLON INSULATOR FOR REFLOW

861V509ER	4	Brass	Gold	59	80K0628	4.80	4.34
861V509ER6	4	Brass	Gold	6, 59	80K0630	5.56	5.03

(142218)

75-OHM F PC BOARD CONNECTORS

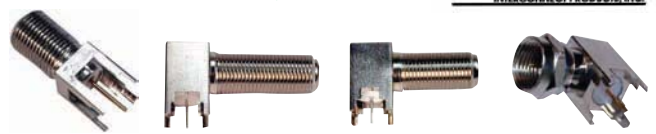

861/864/866 series are decoupled and shielded. Jacks have 4700pF capacitor integrated into the circuit. Fit into standard PC board footprints. Grounding tab for panel cutout.

Mfg. Part No.	Fig.	Body Style	RG/U	Stock No.	Price Each		
					1-24	25-49	50-99
861A509	1	Straight Jack	...	80K0625	1.84	1.66	1.49
864B509	2	Right Angle Jack, Long	...	80K0634	2.62	2.37	2.12
864B509S	3	Right Angle Jack, Short	...	80K0636	2.20	1.99	1.78
866B509	4	Right Angle Plug	...	80K0640	3.54	3.20	2.87

(88065)

BROADCAST GRADE F COMPRESSION CONNECTORS



Just Added

KCC series are manufactured of precision-machined brass with heavy nickel plating. Corrosion-resistant parts feature nickel-plated, semi-captive contacts. Shielding provides isolation from EMI and RFI interference. Each connector is shipped with six color-coded O-rings.



Mfg. Part No.	Body Style	RG/U	Stock No.	Price Each		
				1-24	25-49	50-99
KCC1505F	Straight Plug	59	19P9284	1.42	1.28	1.15
KCC1694F	Straight Plug	6	19P9288	1.42	1.28	1.15
KCC1855F	Straight Plug	59 Mini	19P9292	1.42	1.28	1.15

CRIMP TOOLS

Mfg. Part No.	Description	Stock No.	Price Each	
			1-24	25-49
BDK6000	Crimp Tool for Broadcast Grade Crimp Connectors	19P8368	164.49	148.16

(142258)

F CONNECTORS AND ADAPTERS

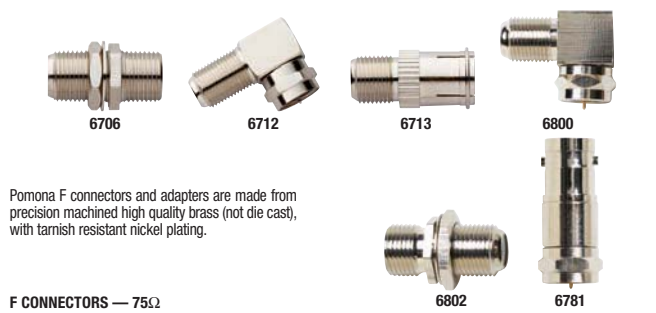

Pomona F connectors and adapters are made from precision machined high quality brass (not die cast), with tarnish resistant nickel plating.

F CONNECTORS — 75Ω

Mfg. Part No.	Description	Stock No.	Price Each	
			1-24	25-49
6706	"F" Bulkhead/Panel Feed-Thru Adapter	61H3188	1.63	1.56

F ADAPTERS

6712	"F" Female-to-Male Right Angle Adapter	61H3194	3.48	3.33
6713	"F" Female-to-Male Push-On Adapter	53H6777	2.56	2.45

CONTINUED

RF COAX MEDIUM

F CONNECTORS AND ADAPTERS (CONT.)

F ADAPTERS

Mfg. Part No.	Description	Stock No.	Price Each	
			1-24	25-49
● 6800	"F" Male-to-Female Right Angle Adapter	02J8356	3.52	3.21
● 6802	"F" Female-to-Female Bulkhead Adapter	02J8358	1.39	1.33

F BETWEEN SERIES ADAPTERS

● 6779	BNC Male-to-F Female Adapter	02J8352	3.41	3.26
● 6780	BNC Female-to-"F" Female Adapter, 75Ω	02J8353	3.41	3.26
● 6781	BNC Female-to-"F" Male Adapter, 75Ω	02J8354	3.41	3.26
● 6782	BNC Male-to-"F" Male Adapter, 75Ω	02J8355	3.41	3.26

(75868)

VOLTREX® BRAND F CONNECTORS



VOLTREX® brand

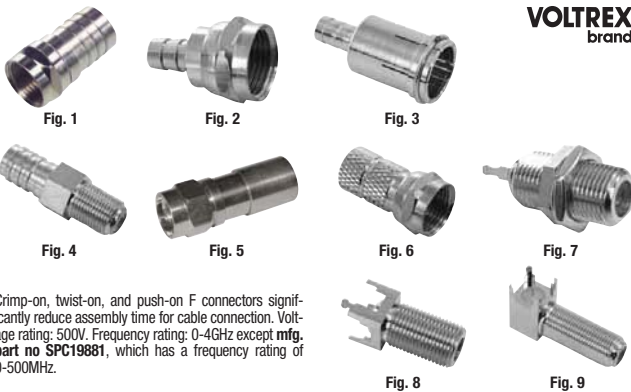

Crimp-on, twist-on, and push-on F connectors significantly reduce assembly time for cable connection. Voltage rating: 500V. Frequency rating: 0-4GHz except mfg. part no SPC19881, which has a frequency rating of 0-500MHz.

CRIMP-ON PLUGS WITH FERRULE

Mfg. Part No.	Fig.	RG/U	Crimp Tool	Stock No.	Price Each		
					1-249	250-499	500-999
SPC32721*	1	59	24-7710	50P9923	0.65	0.49	0.44
● SPC15360	1	59	...	79K4949	0.93	0.70	0.62
● SPC15433	1	6	...	79K5013	0.99	0.74	0.66
● SPC4213	1	6TS	CTR-8572-01	84N1543	0.72	0.54	0.48
● SPC4214	1	6	CTR-8572-01	84N1544	0.87	0.65	0.58
● SPC15360*	1	59	CTR-8572-01	79K4949	0.93	0.70	0.62
● SPC15212	2	59	CT-100-F	79K4814	1.61	1.21	1.08
● SPC15129	3	79K4745	1.56	1.17	1.05
● SPC21093†	4	59	CTR-8572-01	10M8344	2.24	1.74	1.56

WEATHERPROOF CRIMP-ON PLUGS

Mfg. part no. 2765 is gel-filled with an O-ring seal. mfg. part no. 2767 Snap-N-Seal plug includes a locking nut to weatherproof head-end of connector; order mfg. part no.1737.

● 2765-SPC	1	6	CTR-8572-01	92N5307	1.48	1.27	1.14
● 2766-SPC	1	6	CTR-8572-01	92N5308	0.97	0.73	0.64
● 2767-SPC	5	6QS	1737	92N5309	2.14	1.84	1.65

TWIST-ON PLUGS

● SPC15286	6	59	...	79K4883	0.88	0.66	0.59
------------	---	----	-----	---------	------	------	------

CHASSIS-MOUNT FITTINGS

● CPF-61-AD	7	84N542	1.81	1.56	1.39
-------------	---	-----	-----	--------	------	------	------

75-OHM PC BOARD MOUNT JACKS

Right-angle jacks mfg. part no. SPCF23PC-RA with 33mm extended length and mfg. part no 8589-0940 with 28mm extended length.

● SPCF-22FPC	8	46N7378	1.52	1.38	1.23
● SPCF23PC-RA	9	89N1549	3.76	3.08	2.82
● 8589-0940	9	16N8642	2.40	2.18	1.94

*Commercial Grade; †Crimp-On Jack; ‡Quick Disconnect (17758)

MEDIUM-SIZE, WEATHERPROOF C COAXIAL CONNECTORS



Amphenol® RF Global RF Solutions

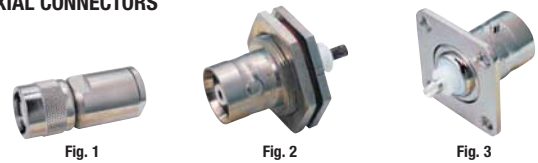

Standard peak rating of 1500V and low VSWR to 10GHz. Mfg. part no. 82-532 peak rating of 4000V and good performance to 2GHz. Coupled by two stud bayonet lock, connectors provide constant 50-ohm impedance and may be used with 75-ohm cable below 300MHz. Temperature range: -55°C to +165°C. Hermetically sealed. Meet MIL-C-39012.

Mfg. Part No.	Fig.	MIL No.	Description	RG/U	Stock No.	Price Each	
						1-9	10-99
● 82-532	1	UG-628B	Straight Plug	8, 9, 87, 213, 214, 225	82K8901	96.03	96.03
● 82-530	1	UG-573A	Straight Plug	8, 9, 87A, 214, 313, 225	73K4060	144.29	144.29
82-515	2	UG-634	Bulkhead Receptacle	...	39F1141	87.25	87.25
● 82-504	3	UG-568	Panel Receptacle	...	59K0526	46.40	46.40

(8247)

50-OHM ZDC SERIES MINI-UHF CONNECTORS



Tyco Electronics

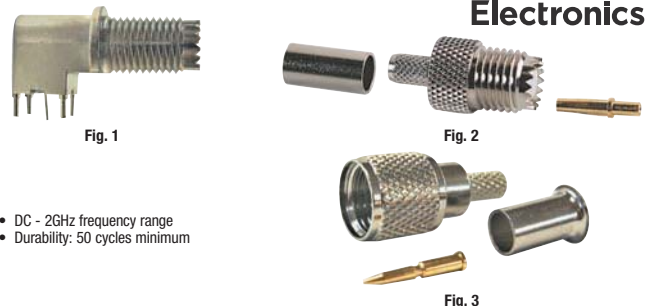

- DC - 2GHz frequency range
- Durability: 50 cycles minimum

RIGHT ANGLE JACK (TIN-PLATED PHOSPHOR BRONZE CONTACTS)

Mfg. Part No.	Fig.	RG/U	Coaxial Termination	Connector Mounting	Stock No.	Price Each	
						1-49	50-99
● 5-1814820-1	1	...	Solder	PC Board	78M7258	2.83	2.50

STRAIGHT JACK (GOLD-PLATED BRASS CONTACTS)

● 5-1814819-1	2	58, 141	Crimp	Cable	78M7257	2.62	2.31
---------------	---	---------	-------	-------	---------	------	------

STRAIGHT PLUG (GOLD-PLATED BRASS CONTACTS)

● 5-1814818-1	3	58, 141	Crimp	Cable	78M7256	1.76	1.55
---------------	---	---------	-------	-------	---------	------	------

(108531)

ZDC SERIES UHF CONNECTORS



Tyco Electronics

- DC - 500MHz frequency range
- Non-constant impedance
- Durability: 50 cycles minimum



STRAIGHT BULKHEAD JACK (TIN-PLATED BRASS CONTACTS)

Mfg. Part No.	Fig.	Coaxial Termination	Connector Mounting	Stock No.	Price Each	
					1-49	50-99
● 5-1814814-1	1	Solder	Bulkhead	78M7253	1.76	1.55

STRAIGHT BULKHEAD JACK (GOLD-PLATED BRASS CONTACTS)

● 5-1814815-1	1	Solder	Bulkhead	78M7254	2.66	2.35
---------------	---	--------	----------	---------	------	------

STRAIGHT JACK (GOLD-PLATED BRASS CONTACTS)

● 5-1814816-1	2	Solder	Panel	78M7255	2.94	2.60
---------------	---	--------	-------	---------	------	------

(108532)



eInvoices

Now you can view, print or email Newark invoices from our website under MY ACCOUNT eSuite. Log in or register today.

(148830)

RF COAX MEDIUM

50-OHM MINI-UHF CONNECTORS



- Nickel-plated bodies
- Gold-plated beryllium copper contacts (jacks)



Fig. 1



Fig. 2

STRAIGHT JACK

Mfg. Part No.	Fig.	RG/U	Coaxial Termination	Connector Mounting	Stock No.	Price Each	
						1-24	25-99
● 5226601-1	1	...	Solder	Panel	96M0669	5.18	
● 5226601-3	1	...	Solder	Panel	96M0670	5.68	

STRAIGHT BULKHEAD JACK

● 5414045-1	2	58	Crimp	Panel	96M0673	5.75	
● 5228665-2	2		Crimp	Panel	96M0672	7.43	

(112561)

AMP UHF CONNECTORS



226600-1



5226602-1

Polypropylene dielectric. Order hand tools separately on page 1039. See Product Index for a complete selection of coaxial cable.

STANDARD DUAL CRIMP UHF PLUGS

Mfg. Part No.	RG/U	Plating Center Contact/Body	Length	Stock No.	Price Each		
					1-24	25-49	50-99
● 5226600-1	58, 58A, 58B, 58C	Tin/Nickel	1.140"	42K7121	1.49	1.35	1.23
● 2-5330830-4	58	Silver/Nickel	1.317"	16M3890	21.81	20.22	18.04

STANDARD SINGLE CRIMP UHF PLUGS

● 5226279-1	58, 58A, 58B, 58C	Tin/Nickel	1.500"	42K7120	12.38	10.65	9.41
● 226279-2	213, 8, 8A	Tin/Nickel	1.500"	35K5273	38.87	33.54	29.69

MINIATURE DUAL CRIMP UHF JACK

● 5226602-1	58, 58A, 58B, 58C	Tin/Nickel	1.185"	16M3237	5.37	4.62	4.08
-------------	-------------------	------------	--------	---------	------	------	------

(8241)

50-OHM, 237VRMS MINIATURE UHF COAXIAL CONNECTORS



For cellular mobile phone systems, similar applications to 2GHz. Astroplate® finish. Operating temperature: -55°C to +85°C.



81-115N-1000

Mfg. Part No.	Description	Cable RG/U	Stock No.	Price Each	
				1-9	10-49
● 81-115N-1000	Straight Plug, Crimp-Crimp Pin Contact, Gold Plating, Nickel Body	58, 58A, 58C, 141, 303, LMR 195, Belden 7806A	93F7597	3.20	
● 81-116	Straight Jack, Crimp-Crimp Socket Contact, Tin-Lead, Nickel Body	...	46F8243	10.48	
● 81-120	Straight Bulkhead Receptacle, Solder Cup	...	90F8454	2.78	
● 81-115BK-1000	Mini Straight Plug, Crimp-Crimp Gold Plating, Nickel Body	58	93F7541	7.13	

(8249)

RFX™ UHF COAXIAL CONNECTORS



Fig. 1



Fig. 2



Fig. 3



Fig. 4



Fig. 5



Fig. 6

General-purpose for DC to 300MHz with voltage rating of 500V peak. Order tools and die sets separately on pages 1039-1040.

RFX™ UHF CABLE PLUGS—MALE CONTACTS

Mfg. Part No.	Fig.	RG/U	Stock No.	Price Each			
				1-9	10-24	25-99	100-499
● 83-1SP-15RFX	1	8, 9, 11, 13, 63, 87A, 149	93F1465	1.99	1.81	1.54	1.43
● 83-58DCP-2RFX	...	58, 58A, 58C, 141, 303, LMR 195, Belden 7806A	73K1496	3.34	3.05	2.82	2.61
● 83-58FCP-RFX	2	58, 141	93F1466	2.71	2.48	2.28	2.12
● 83-59	3	8, 9, 87A, 214, 313, 225	39F1061	180.91	160.81	143.03	133.75
● 83-59SP	...	59, 62, 140, 210, Belden 8241, 8263, 8279, 9209	60K7161	31.05	21.93	16.49	14.74
● 83-8SP-RFX	...	59	19C5196	2.67	2.44	2.25	2.09

RFX™ REDUCING ADAPTERS

For cable plugs, order separately above.

● 83-185-RFX	4	58, 141, 142	93F1468	0.60	0.54	0.45	0.41
● 83-168-RFX	4	59, 62, 71, 140, 210	93F1467	0.55	0.46	0.43	0.39

RFX™ UHF RECEPTACLES

Mfg. Part No.	Fig.	Description	Stock No.	Price Each			
				1-9	10-24	25-99	100-499
● 83-1R-RFX	5	Panel Receptacle, 4 Hole Sq. Flange	73K1494	3.50	3.12	2.80	2.52
● 83-878-RFX	6	Bulkhead Receptacle, Rear Mount	93F1470	4.58	4.16	3.82	3.27

ACCESSORIES

Mfg. Part No.	Description	Stock No.	Price Each	
			1-9	10-49
● 83-1AC-RFX	Protective Cap with Chain	82K8906	1.96	

(8271)

UHF 500-VOLT, NON-CONSTANT IMPEDANCE COAXIAL CONNECTORS



Fig. 1

Fig. 2

Fig. 3

Fig. 4

Fig. 5



Fig. 6



Fig. 7



Fig. 8



Fig. 9

Operate to 300MHz. Temperature range: -50°C to +149°C. Order tools and die sets separately on pages 1039-1040.

Mfg. Prt No.	Fig.	MIL No.	Description	RG/U	Stock No.	Price Each	
						1-9	10-49
● 83-1SP (PL-259)	1	PL-259	Plug, Silver Plate Body	8,9,11,13,63,87,149	59K0534	4.66	
● 83-1SP-1050	1	PL-259	Plug, Astroplate Body	213,214,216,225	73K1495	3.71	
● 83-822 (PL-259)	1	PL-259	Plug, Teflon™ Insulator	8,9,11,13,63,87,149,213,214,216,225	59K0538	7.22	
● 83-58SP	2	...	Straight Plug, Crimp	58,141	59K0535	20.83	

▶ CONTINUED ▶

UHF 500-VOLT, NON-CONSTANT IMPEDANCE COAXIAL CONNECTORS (CONT.)

Mfg. Part No.	Fig.	MIL No.	Description	RG/U	Stock No.	Price Each	
						1-9	10-99
● 83-58FCP	Straight Plug	58 Quick Assembly	39F1075	19.18	
● 83-750 (UG-111/U)	1	UG-111U	Straight Plug	59	59K0536	21.78	
● 83-878	3	...	Bulkhead Receptacle, Rear Mount	...	82K8912		5.40
● 83-1R (SO-239)	...	SO-239	Panel Receptacle	...	73K1493	3.18	
● 83-798 (SO-239A)	...	SO-239A	Panel Receptacle	...	59K0537	5.53	
● 83-1J (PL-258)	4	PL-258	Straight Adapter J-J	...	82K8908		10.94
● 83-877	5	...	Straight Adapter P-P	...	82K8911		41.61
● 83-1AP (UG-646/U)	...	UG-646	Angle Adapter J-P	...	73K1492	14.22	
● 83-1T (M-358)	6	M-358	Tee Adapter J-P-J	...	82K8909	17.28	
● 83-1F (UG-363/U)	7	UG-363	Bulkhead Adapter J-J	...	82K8907		21.07
● 83-168 (UG-176/U)	...	UG-176	Reducing Adapter	59,62,71,140,210	39F041	6.60	
● 83-765 (UG-177/U)	8	UG-177	Hood for 83-1R	58,141	39F038	7.23	
● 83-1H	8	UG-106/U	Hood, 4-Hole	8,10,11,12, 63,79,115, 149,213,215	83F6739		6.81
● 83-1AC	9	...	Cap and Chain	...	39F042	18.26	

(8201)

50-OHM EGO SERIES N COAXIAL CONNECTORS

Just Added



- Frequency range: DC to 6GHz
- Screw on coupling
- Compliant to CECC and IEC standards
- Bright bronze-plated brass connector body and outer contact
- Gold-plated bronze female center contact
- PTFE / Polypropylene insulator

JACKS

Mfg. Part No.	Body Style	Connector Mounting	Coaxial Termination	RG/U	Stock No.	Price Each
R161A404000	Straight Flanged	Panel	Solder	...	11R6467	1.46
R161A410000	Straight Flanged	Panel	Solder	...	11R6468	1.71
R161A606010	Straight Bulkhead	Panel	Solder	...	11R6469	2.26

PLUGS

Mfg. Part No.	Style	Cable	Crimp	RG/U	Stock No.	Price Each
R161A082000	Straight	Cable	Crimp	58, 141	11R6460	1.92
R161A083000	Straight	Cable	Crimp	142, 223, 400	11R6461	1.92
R161A075000	Straight	Cable	Crimp	213	11R6459	1.82
R161A088000	Straight	Cable	Crimp	214	11R6462	1.82
R161A182000	Right Angle	Cable	Crimp	58, 141	11R6463	2.42
R161A183000	Right Angle	Cable	Crimp	142, 223, 400	11R6464	2.42
R161A184000	Right Angle	Cable	Crimp	213	11R6465	3.00
R161A186000	Right Angle	Cable	Crimp	214	11R6466	3.00

(148763)

50-OHM UHF AND MINI-UHF CONNECTORS



VOLTREX® brand



All connectors have a voltage rating of 500Vrms with a frequency rating of 0-2GHz, except mfg. part no. 1532-1534, which have a frequency rating of 0-300MHz and mfg. part no. 1507 which has a voltage rating of 335Vrms. Mfg. part nos SPC19892 - SPC 19899 have a frequency rating of 0-500MHz. Feature Delrin insulation except, mfg. part no. 1532, which is Bakelite and mfg. part nos. 1533, 1534 which are Teflon®. Mfg. part nos. numbers with (*) have brass contacts. Mfg. part nos. with (+) have brass contacts with silver finish except mfg. part no. 1507, which have a brass contact with gold finish.

UHF CRIMP PLUGS

Mfg. Part No.	Fig.	RG/U	AWG	Stock No.	Price Each	
					1-49	50-99
● 1532+	1	58, 58A, 58C, 141, LMR200	20	92N3378	5.10	4.17
● 1534+	1	58, 58A, 58C, 141, LMR200	20	92N3380	3.30	2.85
● SPC19892†	1	8	...	83K0866	1.79	1.62
● SPC19893*	1	58	20	83K0867	3.49	3.01
● SPC23497*	1	8	16	88M1515	5.80	4.75
● SPC19898*	1	58	20	83K0872	3.83	3.04
● 1533+†	2	8, 8A, 9, 9A, 9B, 213, 214	22	92N3379	3.22	2.85
● MC23548	...	142	...	96M8832	2.01	1.61
● MC23544\$...	213	...	96M8828	1.79	1.62
● SPC19899*††	83K0873	2.13	1.83

UHF SOLDER JACKS

● SOCKET, UHF BULKHEAD*	...	223	...	25M7492	1.88	1.51
● MC23547*	96M8831	1.53	1.22

MINI-UHF CRIMP PLUGS

● MINI-UHF-59	3	59, 62	...	87N822	3.01	2.40
● SPC19900†	3	8X	...	83K0874	2.92	2.34
● 1507*	4	58, 58A, 58C, 141, 141A, 400	20	92N3353	2.22	1.93

†Solder; ‡Female 4 Hole Flange Mount; §Twist-On (82072)

UHF CONNECTORS AND ADAPTERS

Just Added



- Gold-plated phosphor bronze contacts

STRAIGHT PLUGS

Mfg. Part No.	Connector Mounting	Coaxial Termination	RG/U	Stock No.	Price Each
73059	Cable	Clamp	8, 9, 11, 63, 87A, 213, 214, 225	08R6363	5.86

ADAPTERS

Mfg. Part No.	Body Style	Convert From	Convert To	Stock No.	Price Each
					Each
73058	Straight	UHF Jack	UHF Jack	08R6362	8.76

(147914)

AMP 50- AND 75-OHM DIN 1.0/2.3 CONNECTORS



- Gold-plated phosphor bronze contacts (jacks)
- Gold-plated brass contacts (plugs)
- Snap-on, push-pull coupling

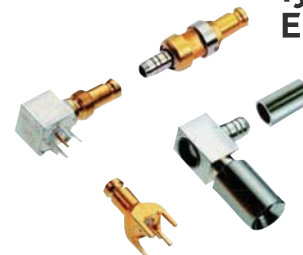

STRAIGHT JACK

Mfg. Part No.	Impedance (Ohms)	Coaxial Termination	Connector Mounting	Stock No.	Price Each	
					1-24	25-49
● 6274431-1	75	Solder	PC Board	96M0690	7.76	7.12

RIGHT ANGLE BULKHEAD JACK

● 1274544-1	50	Solder	Panel	96M0624	3.62	3.32
-------------	----	--------	-------	---------	------	------

TERMINATOR PLUG

● 619219-1	96M0686	9.63	8.82
------------	-----	-----	-----	---------	------	------

(114906)

eQuotes



Retrieve and process Newark quotes online from our website under MY ACCOUNT eSuite. Or email them to your Purchasing department. Log in or register today.

Make it easy. Make it fast. Make it Newark.

(148834)

RF COAX LARGE • RF COAX – ADAPTERS

1.0/2.3 SERIES CONNECTORS



102-799-04DB

102-799-050

Features:

- Push-Pull Coupling with Patented Locking Mechanism Allows Quick Installation
- Push-Pull Offers Safe Coupling
- Eliminates Cross-Threading Problems and Field Problems
- Connectors Can Be More Densely Packed, Saving Panel Space

Applications:

- Base Stations, Cable Assemblies, Components (Filters), Datacom, Routers, Switching Equipment, Telecom

The compact design of 1.0/2.3 series connectors permit dense packing. Ideally suited to applications where space is limited. Threaded coupling provides positive mating and locking. Connectors are 50-ohm units operating from 0-10GHz. Adapters ordered separately, go online or call.

STRAIGHT CABLE PLUGS FOR SEMI-RIGID AND FLEXIBLE CABLE

Mfg. Part No.	Cable	Stock No.	Price Each	
			1-9	
● 102-799-16	RG174, 179, 188, 316	36C2890	15.95	
● 102-799-48	LMR240	36C2892	10.23	

50-OHM TERMINATOR

Mfg. Part No.	Power	Stock No.	Price Each	
			1-9	
● 102-799-050	¼W	36C2887	12.38	

BETWEEN SERIES ADAPTERS

Mfg. Part No.	Description	Stock No.	Price Each	
			1-9	
● 901-10005	SMA Plug to 1.0/2.3 Jack Adapter	30C1341	68.20	
● 901-10006	SMA Jack to 1.0/2.3 Plug Adapter	01C0679	49.00	
● 901-10007	SMA Plug to 1.0/2.3 Plug Adapter	30C1342	64.42	
● 901-10008	SMA Jack to 1.0/2.3 Jack Adapter	30C1343	77.58	

(69829)

BETWEEN SERIES ADAPTERS

Just Added



- Provide convenient transitions between popular series coaxial connectors
- Design provides a minimum length with good electrical performance
- Small size, low VSWR, and broad frequency permits a wide range of applications in both measurement and system use

Mfg. Part No.	Convert From	Convert To	Stock No.	Price Each	
				1-9	
● 448091-2	SMP Plug	SMA Jack	13H4618	71.54	
● 1058058-1	BNC Jack	SMA Jack	89C0039	36.78	
● 3082 2321 00	N Jack	BNC Plug	07H8302	104.88	
● 1058651-1	N Jack	SMA Jack	10H7263	170.34	
● 3680-2242-00*	N Jack	SMA Jack	37K7341	169.78	
● 1058664-1	N Jack	SMA Plug	96M0604	101.48	
● 1058666-1*	N Plug	SMA Jack	96M0605	144.64	
● 1053783-1	N Plug	SMA Jack	96M0590	278.19	
● 2380 2240 00	OSMT Jack	SMA Jack	79C3884	202.01	
● 1059733-1	OSP Jack	SMA Jack	10H7315	84.99	
● 1059750-1*	OSP Jack	SMA Jack	96M0606	114.66	
● 1059716-1	OSP Plug	SMA Jack	10H7310	32.73	
● 1059928-1	OSSP Jack	SMA Jack	10H7321	113.99	
● 1056702-1	SMA Jack	OSMP Jack	96M0596	232.17	
● 1058755-1*	SMA Jack	TNC Jack	06M6683	122.78	
● 4583-2240-02	SMA Jack	OSP Jack	24K0650	116.03	
● 1083442-1†	SMA Jack	OSP Plug	29C5229	95.76	
● 1056708-1	SMA Plug	OSMP Jack	96M0597	135.38	
● 3081 2241 00	SMA Plug	N Plug	50B8816	142.85	
● 1060274-1	SMA Plug	SMC Jack	10H7334	79.83	
● 1058077-1	SMB Plug	BNC Jack	96M0602	56.28	
● 3180 2242 00*	TNC Jack	SMA Jack	07H8316	110.42	
● 1058800-1†	TNC Jack	SMA Jack	94C2891	195.72	
● 3182 2240 00	TNC Plug	SMA Jack	07H8320	74.10	
● 1058662-1	TNC Plug	N Plug	96M0603	109.73	

* Flange Mount; † Bulkhead Adaptor. (113234)

AMP RF INTER-SERIES ADAPTERS



- Provide convenient transitions between popular series coaxial connectors
- Design provides a minimum length with good electrical performance
- Small size, low VSWR, and broad frequency permits a wide range of applications in both measurement and system use

Mfg. Part No.	Description	Stock No.	Price Each	
			1-24	25-49
● 3082 2320 00	N Plug-to-BNC Jack	07H8301	112.47	102.99
● 1060498-1	SMB Plug-to-SMA Jack	10H7347	58.93	50.68
● 1060487-1	SMA Jack-to-SMB Jack	20C2682	47.65	40.98
● 1057381-1	SMA Plug-to-N Jack	27C1734	71.13	61.17
● 3282 2241 00	SMA Plug-to-BNC Jack	50B479	57.18	52.36
● 1058058-1	SMA Jack-to-BNC Jack	89C0039	36.78	36.78
● 3080 2242 00*	SMA Jack-to-N Jack	94C2642	218.55	196.70
● 1057463-1†	SMA Jack-to-N Jack	97C6564	97.32	87.59
● 4584 2242 02	SMA Jack-to-OSP Jack	20C8284	101.83	93.26
● 3282 2240 00	BNC Plug-to-SMA Jack	24C4956	55.44	49.90
● 4585 2240 02	OSP Plug-to-SMA Jack	30C1725	51.34	46.21
● 3284 2240 00	BNC Jack-to-SMA Jack	90B8519	56.86	52.07
● 3082 2240 00	N Plug-to-SMA Jack	92B3152	102.22	92.00

* Flange Mount; † Bulkhead Adaptor. (80549)

BETWEEN-SERIES ADAPTERS



These between-series adapters are used to join 2 connectors of different series. Designed to offer the lowest VSWR rating of the 2 series involved. Mfg. part nos. with RP suffix are used for reverse polarized connectors.



Mfg. Part No.	Desc.	Stock No.	Price Each	
			1-9	10-24
● 242102	SMA Plug-to-BNC Jack	92C7247	4.84	3.76
● 242103	SMA Jack-to-BNC Plug	92C7248	9.91	8.80
● 242123	SMA Jack-to-BNC Jack	92C7271	8.55	7.74
● 242104	SMA Plug-to-BNC Plug	92C7249	13.45	12.25
● 242181	SMA Jack-to-BNC Jack	92C7327	13.40	12.19
● 242124	SMA Plug-to-TNC Jack	92C7272	9.91	8.99
● 242105	SMA Jack-to-TNC Plug	92C7250	7.13	6.45
● 242106	SMA Plug-to-TNC Plug	92C7252	13.45	12.25
● 242107	SMA Jack-to-TNC Jack	92C7253	16.71	15.32
● 242178	SMA Jack-to-TNC Jack	92C7325	13.45	12.25
● 242144	SMA Plug-to-SMB Jack	92C7294	13.45	12.25
● 242145	SMA Jack-to-SMB Plug	92C7295	12.63	11.59
● 242146	SMA Plug-to-SMB Plug	92C7297	12.45	11.48
● 242147	SMA Jack-to-SMB Jack	92C7298	13.45	12.25
● 242182	SMA Jack-to-SMB Jack	92C7328	13.45	12.25
● 242174	SMA Plug-to-SMC Jack	92C7321	17.33	15.84
● 242175	SMA Jack-to-SMC Plug	92C7322	17.33	15.84
● 242176	SMA Plug-to-SMC Jack	92C7323	17.33	15.84
● 242177	SMA Jack-to-SMC Plug	92C7324	17.33	15.84
● 242112	SMA Plug-to-N Jack	92C7259	9.91	8.99
● 242113	SMA Jack-to-N Plug	92C7261	7.50	6.79
● 242114	SMA Plug-to-N Plug	92C7262	9.91	8.99
● 242115	SMA Jack-to-N Jack	92C7263	9.91	8.99
● 242125	SMA Jack-to-N Jack	92C7273	7.38	6.95
● 242163	SMA Jack-to-N Jack	92C7310	9.06	8.26
● 242109	SMA Jack-to-UHF Plug	92C7256	17.33	15.84
● 242111	SMA Jack-to-UHF Jack	92C7258	17.33	15.84
● 242116	SMA Plug-to-Mini-UHF Jack	92C7264	17.33	15.84
● 242119	SMA Jack-to-Mini-UHF Jack	92C7267	17.33	15.84
● 242126	SMA Plug-to-MCX Jack	92C7274	17.33	15.84
● 242127	SMA Jack-to-MCX Plug	92C7275	11.31	10.21
● 242128	SMA Plug-to-MCX Plug	92C7276	19.59	17.90
● 242140	SMA Plug-to-MMCX Jack	92C7290	13.45	12.25
● 242141	SMA Jack-to-MMCX Plug	92C7291	12.33	11.22
● 242142	SMA Plug-to-MMCX Plug	92C7292	13.45	12.25
● 242143	SMA Jack-to-MMCX Jack	92C7293	13.45	12.25
● 242193	SMA Jack-to-MMCX Jack	09J8787	17.33	15.84
● 242200	SMA Plug-to-SSMB Jack	09J8791	17.33	15.84
● 242207	SMA Plug-to-1.0/2.3 Jack	09J8793	23.11	21.12
● 242179	SMA Jack-to-1.0/2.3 Jack	99H6424	21.12	15.97
● 242189	SMA Plug-to-SSMA Jack	99H6426	17.33	15.84
● 242170	N Plug-to-MCX Jack	92C7317	20.42	18.85
● 242171	N Jack-to-MCX Plug	92C7318	12.16	11.08
● 242173	N Plug-to-MCX Plug	92C7320	21.12	18.51

➔ CONTINUED ➔

BETWEEN-SERIES ADAPTERS (CONT.)

Mfg. Part No.	Dsc.	Stock No.	Price Each	
			1-9	10-24
● 242166	N Plug-to-MMCX Jack	92C7313	21.12	19.83
● 242167	N Jack-to-MMCX Plug	92C7314	20.42	18.85
● 242168	N Jack-to-MMCX Jack	92C7315	20.42	18.85
● 242169	N Plug-to-MMCX Plug	92C7316	23.11	21.12
● 242121	N Plug-to-BNC Jack	92C7269	13.45	12.25
● 242101	N Jack-to-BNC Plug	92C7246	13.45	12.25
● 242100	N Jack-to-BNC Jack	92C7245	16.71	15.32
● 242162	N Jack-to-BNC Jack	92C7309	22.00	20.08
● 242122	N Plug-to-BNC Plug	92C7270	16.71	15.32
● 242130	N Plug-to-TNC Jack	92C7278	15.32	13.00
● 242131	N Jack-to-TNC Plug	92C7280	10.21	9.35
● 242132	N Jack-to-TNC Jack	92C7281	17.33	15.84
● 242133	N Plug-to-TNC Plug	92C7282	17.33	15.84
● 242156	N Plug-to-F Jack	92C7306	10.56	9.44
● 242152	N Jack-to-F Plug	92C7303	17.33	15.84
● 242157	N Plug-to-F Plug	92C7307	17.85	16.32
● 242120	N Jack-to-F Jack	92C7268	17.33	15.84
● 242135	N Plug-to-7/16 Jack	92C7285	52.80	41.44
● 242136	N Jack-to-7/16 Plug	92C7286	52.80	48.38
● 242137	N Jack-to-7/16 Jack	92C7287	57.64	52.54
● 242138	N Plug-to-7/16 Plug	92C7288	47.12	45.03
● 272183	N Jack-to-7/16 Jack	09J8795	61.71	56.25
● 242183	N Jack-to-SMB Jack	99H6425	16.43	15.38
● 242198	N Jack-to-SMB Jack	09J8789	22.16	20.03
● 242184	BNC Plug-to-SMB Jack	92C7329	13.45	12.25
● 242185	BNC Jack-to-SMB Plug	92C7330	9.91	8.81
● 242186	BNC Jack-to-SMB Jack	92C7331	13.45	12.25
● 242187	BNC Plug-to-SMB Plug	92C7332	13.45	12.25
● 242148	BNC Plug-to-TNC Jack	92C7299	12.45	11.70
● 242149	BNC Jack-to-TNC Plug	92C7300	5.97	5.40
● 242150	BNC Jack-to-TNC Jack	92C7301	16.71	15.32
● 242151	BNC Plug-to-TNC Plug	92C7302	16.71	15.32
● 242134	BNC Plug-to-UHF Jack	92C7284	13.45	12.45
● 242164	BNC Jack-to-UHF Plug	92C7311	14.45	13.20
● 242165	BNC Jack-to-UHF Jack	92C7312	17.33	15.84
● 242154	BNC Plug-to-F Jack	92C7305	16.71	15.32
● 242199	BNC Jack-to-F Plug	09J8790	11.56	10.56
● 242161	BNC Jack-to-F Jack	92C7308	17.33	15.84
● 242153	Mini-UHF Plug-to-UHF Jack	92C7304	5.94	5.41
● 242197	Mini-UHF Jack-to-TNC Plug	09J8788	17.33	15.84
● 242203	BNC Plug-to-MCX Jack	73J7934	17.33	15.84
● 242204	BNC Jack-to-MCX Plug	73J7935	11.56	10.56
● 242205	BNC Plug-to-MCX Plug	73J7936	17.33	15.84
● 242206	BNC Jack-to-MCX Jack	73J7937	14.45	13.20
● 242208	TNC Plug-to-MCX Jack	09J8794	15.32	14.14
● 242209	TNC Jack-to-MCX Plug	73J7938	12.77	11.78
● 242210	TNC Plug-to-MCX Plug	73J7939	15.32	14.14
● 242211	TNC Jack-to-MCX Jack	73J7940	12.77	11.78
● 242192	TNC Jack-to-U. FL Jack	09J8785	13.44	12.25
REVERSE POLARITY (RP) ADAPTERS				
● 132168RP	SMA Plug-to-SMA RP Plug	09J8780	10.19	9.18
● 132170RP	SMA Jack-to-SMA RP Jack	09J8782	10.09	9.09
● 132171RP	SMA Plug-to-SMA RP Jack	92C6703	5.14	4.72
● 132171RP-10	SMA RP Plug-to-SMA Jack	92C6705	5.61	4.96
● 132171RP-RP	SMA RP Plug-to-SMA RP Jack	92C6704	8.72	7.95
● 132172RP	SMA Plug-to-SMA RP Jack	92C6706	7.16	6.32
● 242105RP	SMA Jack-to-TNC RP Plug	92C7251	14.74	13.21
● 242107RP	SMA Jack-to-TNC RP Jack	92C7254	14.79	13.24
● 242112RP	SMA RP Plug-to-N Jack	92C7260	10.90	9.80
● 242145RP	SMA Jack-to-SMB RP Plug	92C7296	17.65	16.09
● 172212RP	N RP Plug-to-N Plug	92C6739	9.65	8.64
● 172213RP	N RP Jack-to-N Plug	92C6740	7.95	7.43
● 242130RP	N Plug-to-TNC RP Jack	92C7279	14.75	13.24
● 242131RP	N Jack-to-TNC RP Plug	09J8783	13.24	12.15
● 242132RP	N Jack-to-TNC RP Jack	09J8784	13.24	12.15
● 242133RP	N Plug-to-TNC RP Plug	92C7283	16.50	15.34
● 242192RP	U.FL Jack-to-TNC RP Jack	09J8786	15.38	14.25

(73112)

BETWEEN SERIES ADAPTERS



▶ CONTINUED ▶

RF COAX – ADAPTERS

BETWEEN SERIES ADAPTERS (CONT.)

Solve a variety of connection problems where connectors of different types ordinarily could not be mated together. Each adapter has a different coupling at each end allowing for a wide variety of interconnections. All adapters are constructed of machined brass and are nickel plated.

Mfg. Part No.	Fig.	Convert From	Convert To	Stock No.	Price Each		
					1-24	25-49	50-99
1303505	1	N Plug	BNC Plug	79K9720	35.97	32.59	29.07
1313505	2	N Plug	BNC Jack	79K9730	13.36	12.10	10.80
1323505	3	N Jack	BNC Jack	79K9737	11.84	10.73	9.57
1307505	4	N Plug	UHF Plug	79K9724	19.18	17.38	15.51
1317505	5	N Plug	UHF Jack	79K9733	19.98	18.10	16.15
1327505	6	N Jack	UHF Jack	79K9739	16.82	15.24	13.59
7311505	7	UHF Plug	N Jack	80K0502	20.59	18.66	16.65
1308505	8	N Plug	F Plug	79K9725	9.21	8.34	7.44
1318505	9	N Plug	F Jack	79K9734	20.03	18.15	16.19
1318705	9	N Plug	F Jack	63M9756	19.40	17.57	15.68
1328505	10	N Jack	F Jack	79K9741	68.00	61.82	59.65
1309505	11	N Plug	SMA Plug	79K9726	37.91	34.35	30.64
1319505	12	N Plug	SMA Jack	79K9735	16.47	14.92	13.31
1329505	13	N Jack	SMA Jack	79K9742	47.22	42.78	38.17
9311505	14	SMA Plug	N Jack	80K0760	33.20	30.08	26.84
1325505	15	N Jack	TNC Jack	79K9738	24.16	21.89	19.53
5311505	16	TNC Plug	N Jack	80K0426	9.26	8.39	7.49
3315505	17	BNC Plug	TNC Jack	80K0200	6.55	5.93	5.29
3325505	18	BNC Jack	TNC Jack	80K0208	19.42	17.60	15.70
5313505	19	TNC Plug	BNC Jack	80K0427	7.00	6.34	5.66
3316505	20	BNC Plug	Mini-UHF Jack	80K0202	10.91	9.89	8.82
6313505	21	Mini-UHF Plug	BNC Jack	80K0476	11.50	10.42	9.29
3307505	22	BNC Plug	UHF Plug	80K0197	19.82	17.96	16.02
3317505	23	BNC Plug	UHF Jack	80K0203	10.25	9.28	8.28
3327505	24	BNC Jack	UHF Jack	80K0209	19.45	17.62	15.72
7313505	25	UHF Plug	BNC Jack	80K0504	12.08	10.95	9.77
3318505	26	BNC Plug	F Jack	80K0204	6.15	5.57	4.97
3328505	27	BNC Jack	F Jack	80K0210	7.03	6.37	5.68
8313505	28	F Plug	BNC Jack	80K0563	5.43	4.92	4.39
3309505	29	BNC Plug	SMA Plug	80K0198	32.24	29.21	26.06
3319505	30	BNC Plug	SMA Jack	80K0205	10.62	9.62	8.58
9313505	31	SMA Plug	BNC Jack	80K0761	14.08	12.75	11.38
5316505	32	TNC Plug	Mini-UHF Jack	80K0428	11.04	10.01	8.93
5317505	33	TNC Plug	UHF Jack	80K0429	19.00	17.21	15.36
5309505	34	TNC Plug	SMA Plug	80K0424	16.60	15.04	13.42
5319505	35	TNC Plug	SMA Jack	80K0430	36.26	32.85	29.31
5329505	36	TNC Jack	SMA Jack	80K0432	35.67	32.32	28.84
9315505	37	SMA Plug	TNC Jack	80K0762	33.60	30.44	27.16
6311505	38	Mini-UHF Plug	N Jack	80K0473	18.12	16.42	14.65
6317505	39	Mini-UHF Plug	UHF Jack	80K0478	13.30	12.05	10.75
7316505	40	UHF Plug	Mini-UHF Jack	80K0505	17.03	15.43	13.76
9316505	41	SMA Plug	Mini-UHF Jack	80K0763	40.06	36.30	32.38
7319505	42	UHF Jack	SMA Plug	80K0508	38.73	35.09	31.31
9317505	43	SMA Jack	UHF Plug	80K0764	42.56	38.56	34.40
R0842	44	RCA Plug	BNC Plug	79K8698	5.88	5.33	4.76
R0843	45	RCA Jack	BNC Plug	79K8699	3.46	3.14	2.80
R0844	46	RCA Plug	BNC Jack	79K8700	5.30	4.80	4.28
R0847	47	RCA Plug	F Plug	79K8701	7.05	6.39	5.70
R0849	48	RCA Plug	F Jack	79K8702	3.20	2.90	2.58
R0851	49	RCA Jack	F Plug	79K8703	3.46	3.14	2.80
R0811	50	RCA Jack	UHF Plug	79K8696	4.79	4.34	3.87
R0822	51	RCA Plug	UHF Jack	79K8697	8.73	7.91	7.06

(87998)

ADAPTER KITS



Kits are in zippered leather cases and contain enough parts for hundreds of combinations of adapters. Mfg. part no. ADPT1 is a commercial grade universal adapter kit containing 30 pieces. Mfg. part no. ADPT2 is a broadcast grade universal adapter kit containing 40 pieces. Mfg. part no. ADPT3PA is a tri-plated adapter kit containing 8 pieces. Mfg. part no. ADPT4RP is an antenna universal adapter kit containing 42 pieces. Machined brass and gold plated bodies. Gold contacts.

➔ CONTINUED ➔

ADAPTER KITS (CONT.)

Mfg. Part No.	Kit Contents	Stock No.	Price Each
ADPT1	30 Connectors, 2 each Plugs and Jacks of BNC, TNC, N, Mini-UHF Plugs, UHF, SMA and 6 Universal Adapters	79K5545	218.85
ADPT2	40 Connectors, 2 each Plugs and Jacks of BNC, TNC, N, Mini-UHF, UHF, SMA, F, RCA and 8 Universal Adapters	79K5546	352.22
ADPT3PA	8 Connectors, 7/16 to N, N to N and 7/16 to 7/16 Adapters	19P8198	438.06
ADPT4RP	42 Connectors, N, BNC, UHF, TNC, TNC-RT, TNC-RP, SMA, SMA-RP, 8 Universal Adapters, 2 Wrenches	19P8199	416.64

(89002)

CANNON 50-OHM BETWEEN-SERIES AND IN-SERIES ADAPTERS



Meet MIL-C-39012 specifications.

BETWEEN-SERIES ADAPTERS

Mfg. Part No.	Description	Stock No.	Price Each	
			1-9	10-24
050-674-6700890	SMA Jack-to-N Plug	90F2548	98.12	87.99
050-675-6705890	N Bulkhead Jack-to-SMA Jack	90F2553	26.51	24.01

IN-SERIES ADAPTERS

050-673-0000310	SMA Plug-to-Plug	90F2526	42.09	38.88
050-678-0000310	SMA Plug-to-Jack, Right-Angle	90F2527	64.57	59.65
050-674-6324990	SMA Slide-On Plug-to-SMA Jack	90F6353	54.07	48.68

(8721)

CANNON COAXIAL TERMINATORS

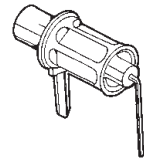

Single Leg

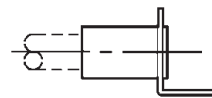

2 Legs



Mfg. Part No.	Description	RG/U	Stock No.	Price Each	
				1-9	10-24
055-939-9019AR6	Single Leg at Front; Single Leg at Rear	178,196	95F6344	1.21	1.09
055-939-9029AR6	Single Leg at Front; Single Leg at Rear	174,179,188	95F6345	1.17	1.04
055-939-9049AR6	2 Legs at Front, Standard	174,179,188,316	95F6347	1.42	1.26
055-939-9069AR6	2 Legs at Front, Surface and Vertical Mount	174,179,188,316	95F6349	2.06	1.87

(8722)

50 OHM BETWEEN-SERIES ADAPTERS

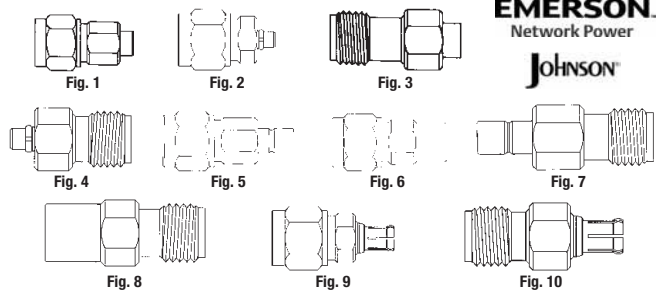

50Ω adapters feature nickel-plated brass body, brass coupling nut, and gold-plated contact. Working voltage: 500Vrms. Dielectric withstanding voltage: 1500Vrms. Durability: 500 cycles. Operating temperature range: -55°C to +85°C.

Mfg. Part No.	Fig.	Description	Freq. Max (GHz)	VSWR (GHz)	Stock No.	Price Each
134-1019-151	1	SMA Plug-to-MMX Jack	6	1.05 + 0.05f	83F6800	44.97
134-1019-161	2	SMA Plug-to-MMX Plug	6	1.05 + 0.05f	83F6801	48.72
134-1019-171	3	SMA Jack-to-MMX Jack	6	1.05 + 0.05f	83F6802	41.23
134-1019-181	4	SMA Jack-to-MMX Plug	6	1.05 + 0.05f	83F6803	44.97
134-1012-011	5	SMA Plug-to-SMB Jack	4	1.05 + 0.01f	83F6804	41.23
134-1012-021	6	SMA Plug-to-SMB Plug	4	1.05 + 0.01f	83F6805	44.97
134-1012-031	7	SMA Jack-to-SMB Plug	4	1.05 + 0.01f	83F6806	41.23
134-1012-041	8	SMA Jack-to-SMB Plug	4	1.05 + 0.01f	83F6807	39.64
134-1018-001	...	SMA Plug-to-MCX Jack	6	1.03 + 0.03f	83F6808	41.23
134-1018-011	9	SMB Plug-to-MCX Plug	6	1.03 + 0.03f	83F6809	44.97
134-1018-021	...	SMA Jack-to-MCX Jack	6	1.03 + 0.03f	83F6810	41.23
134-1018-031	10	SMA Jack-to-MCX Plug	6	1.03 + 0.03f	83F6811	41.23

➔ CONTINUED ➔

50 OHM BETWEEN-SERIES ADAPTERS (CONT.)

Mfg. Part No.	Fig.	Description	Freq. Max (GHz)	VSWR (GHz)	Stock No.	Price Each
● 142-0901-801	...	SMA Jack-to-SMA Jack	18	1.05 + 0.005f	97F923	13.51
● 142-0901-401	...	SMA Jack-to-SMA Bulkhead Jack	18	1.05 + 0.01f	97F922	19.29
● 142-0901-941	...	SMA Right Angle Jack-to-SMA Plug	18	1.035 + 0.02f	01C1652	17.48
● 142-0901-811	...	SMA Plug-to-SMA Plug	18	1.05 + 0.01f	94F9933	15.58
● 142-0901-821	...	SMA Plug-to-SMA Jack	18	1.05 + 0.005f	08B930	14.36

(33011)

50 OHM RF ADAPTER KIT



Kit Includes:

- A variety of interfaces (SMA, N, BNC)
- 72 adapters (in series, between series)

Mfg. Part No.	Description	Stock No.	Price Each
● 142-0000-005	50 ohm RF adapter kit	94H8219	326.03

KIT CONTENTS

Mfg. Part No.	Description	Qty.	Mfg. Part No.	Description	Qty.
142-0901-401	SMA Jack to Bkhd. Jack, Gold Pl.	4	CP-AD515	BNC Plug to RCA Jack	3
142-0901-801	SMA Jack to Jack, Gold Pl.	2	CP-AD555	BNC Jack to Jack	3
142-0901-811	SMA Plug to Plug, Gold Pl.	4	CPA-AD556M	BNC Jack to Bkhd. Jack	2
142-0901-821	SMA Plug to Jack, Gold Pl.	4	CP-AD582	SMA Plug to BNC Plug	3
142-0901-921	RA SMA Jack to Jack, Gold Pl.	2	CP-AD583	SMA Jack to BNC Plug	3
142-0901-931	RA SMA Plug to Plug, Gold Pl.	2	CP-AD800	N Plug to Plug	2
142-0901-941	RA SMA Plug to Jack, Gold Pl.	4	CP-AD356	TNC Jack to Bkhd. Jack	3
142-0901-861	SMA Dummy Load Plug, Gold Pl.	2	CP-AD809	N Plug to BNC Jack	2
CP-AD503	BNC RA BNC Plug to Jack	2	CP-AD810	N Plug to SMA Jack	2
CP-AD505	BNC Jack to Plug to Jack (T)	2	CP-AD817	N Plug to SMA Plug	2
CP-AD506	BNC Jack to Jack to Jack (T)	2	CP-AD818	N Jack to SMA Plug	2
CP-AD507	SMA Jack to BNC Jack	3	CP-AD819	N Jack to SMA Jack	2
CP-AD508	SMA Plug to BNC Jack	3	CP-AD850	N Jack to Jack	2
CP-AD511	BNC Plug to Plug	3	CP-AD851	N Jack to Bkhd. Jack	2

(78141)

RF COAXIAL BETWEEN-SERIES ADAPTERS



1209-17



Mfg. Part No.	Description	Mil. No. 39012/	Stock No.	Price Each
● 1209-17	BNC Jack-to-N Jack, Pressurized	25-00606	50F1455	37.44
● 1209-7	N Plug-to-BNC Jack	20-00201	50F1454	24.02
● KA91-02	TNC Plug-to-N Jack, Hermetically-Sealed	...	88F4416	42.98
● 1209-18	BNC Plug-to-N Jack	49-00349	50F1456	24.27
● 759-6	TNC Jack-to-BNC Jack	37-00001	02H0226	17.82

(8861)

RF COAXIAL WITHIN-SERIES ADAPTERS



2029-17-9

1209-13

1709-12M06

Mfg. Part No.	Description	Mil. No. 39012	Stock No.	Price Each
● 2029-15-9	BNC Jack-to-Jack	...	17B5471	12.45
2029-17-9 QD	BNC Bulkhead Jack-to-Jack, Isolated Ground	...	99K5547	5.48
● 759-5	BNC Plug-to-BNC Plug	15-00491	49H4896	29.58
● 759-2	BNC Bulkhead Jack-to-Jack, Hermetically Sealed	13-00492	50F1445	39.57
● UG-492D/U	BNC Hermetically-Sealed	...	44F8515	43.62
● 1209-9	N Plug-to-N Plug	05-00057	50F1451	17.62
● 1209-12	N Bulkhead, Jack-to-Jack, Hermetically-Sealed	04-00030	50F1452	52.28
● 1209-13	N Jack-to-Jack	07-00029	50F1453	14.97
● 1209-19	N Bulkhead, Hermetically-Sealed	04-0001	17B5429	42.75
● UG-27C/U	N Plug-to-Jack	...	44F8439	44.84

▶ CONTINUED ▶

RF COAXIAL WITHIN-SERIES ADAPTERS (CONT.)

Mfg. Part No.	Description	Mil. No. 39012	Stock No.	Price Each
● 1709-1	SHV Bulkhead, Plug-to-Plug	...	93F6329	28.32
● 1709-12-M06	SHV Angle, Plug-to-Jack	...	95B9389	78.85
● KA-99-56	TNC Bulkhead, Jack-to-Jack, Hermetically-Sealed	...	17B5362	40.99

(8858)

ADAPTER, ATTENUATOR AND TERMINATION KITS



5510



6254

Three versatile adapter kits that include all the connections and terminals you will need. 5510 kit contains one of each: BNC female-to-stacking double banana plug, BNC male-to-stacking double banana plug, BNC male-to-stackable binding posts, BNC female-to-stackable binding posts, BNC female-to-female, BNC male-to-male, and a lightweight foam padded case. 5513 kit contains 5 BNC 50Ω attenuators, one each: 3dB, 6dB, 10dB, 14dB and 20dB all packaged in a lightweight foam padded case. 6254 kit enables a field service technician to connect equipment with 7/16 DIN connectors to equipment with Type N connectors. Kit contains one of each: 7/16 DIN male-to-7/16 DIN female right-angle adapter, 7/16 DIN male-to-Type N male adapter, 7/16 DIN male-to-Type N female adapter, 7/16 DIN female-to-Type N male adapter, 7/16 DIN female-to-Type N female adapter, 7/16 DIN female-to-7/16 DIN female splice, and a zippered case with die-cut foam padding.

Mfg. Part No.	Description	Stock No.	Price Each
● 5510	BNC/Banana/Binding Post Adapter Kit	90F2330	55.80
5513	BNC Attenuator Kit	90F2366	319.85
● 6254	7/16 DIN-to-Type N Adapter Kit	02B1778	543.56

(8932)

UNIVERSAL ADAPTER KITS



5698



5748

Mfg. part no.5698 kit allows users to make their own adapters combinations, such as SMA to BNC or BNC to double banana plugs. Adapter's ends are joined with coupling nuts. Simply choose your combination. All connectors feature gold plated center contacts and silver plated bodies. Contains 2 each: BNC male, BNC female, TNC male, TNC female, SMA male, SMA female, N male, N female; 4 intermediate couplers, 1 double banana plug, 1 double banana jack. Mfg. part no. 5748 maxi kit contains 2 each: BNC male, BNC female, TNC male, TNC female, SMA male, SMA female, N male, N female, UHF male, UHF female, mini UHF male, mini UHF female, F female, RCA male, RCA female; 6 intermediate couplers, 1 double banana plug, 1 double banana jack, 1 sampler.

Mfg. Part No.	Description	Stock No.	Price 1-24
● 5698	Universal Adapter Kit	50F841	178.91
● 5748	Universal Adapter Kit	50F1552	289.45

(8931)

Expert technical support

(148838)

Chat online to our team of engineers, or connect to them through your representative.

RF COAX – ADAPTERS

MULTI-RF DIRECT ADAPTER KIT

Consolidated kit includes most frequently used Multi-RF adapters. Precision-machined brass with nickel plating Gold-plated center contacts.

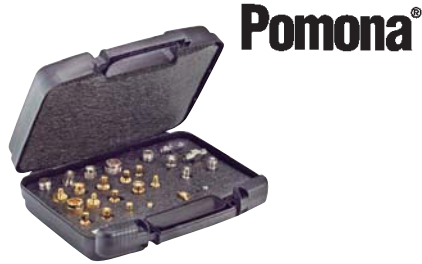

KIT CONTENTS

Mfg. Part No.	Description	Mfg. Part No.	Description
3535	BNC (M) to Type N (F)	4295	SMA (F) to TNC (F)
3288	BNC (F) to Type N (M)	4296	SMA (M) to Type N (F)
3844	TNC (M) to BNC (F)	3283	BNC (F) to F
4288	SMA (M) to BNC (M)	3533	BNC (M) to M
4290	SMA (M) to BNC (F)	3285	BNC (F/M/F) Tee
4289	SMA (F) to BNC (M)	3284	BNC (F/F/F) Tee
4291	SMA (F) to BNC (F)	4940	TNC (F) to F
4298	SMA (M) to Type N (F)	3841	Type N (F) to F
4297	SMA (F) to Type N (M)	3842	Type N (M) to M
4299	SMA (F) to Type N (F)	4282	SMA Right Angle (M to F)
4292	SMA (M) to TNC (M)	4283	SMA (M) to M
4294	SMA (M) to TNC (F)	4284	SMA (F) to F
4293	SMA (F) to TNC (M)	4286	SMA Termination, 50-ohm (M)

Mfg. Part No.	Description	Stock No.	Price Each
72934	SMA Adapter Kit	74K0091	382.40

(88704)

3

INTRA- AND BETWEEN-SERIES COAXIAL ADAPTERS (CONT.)



INTRA- AND BETWEEN-SERIES COAXIAL ADAPTERS

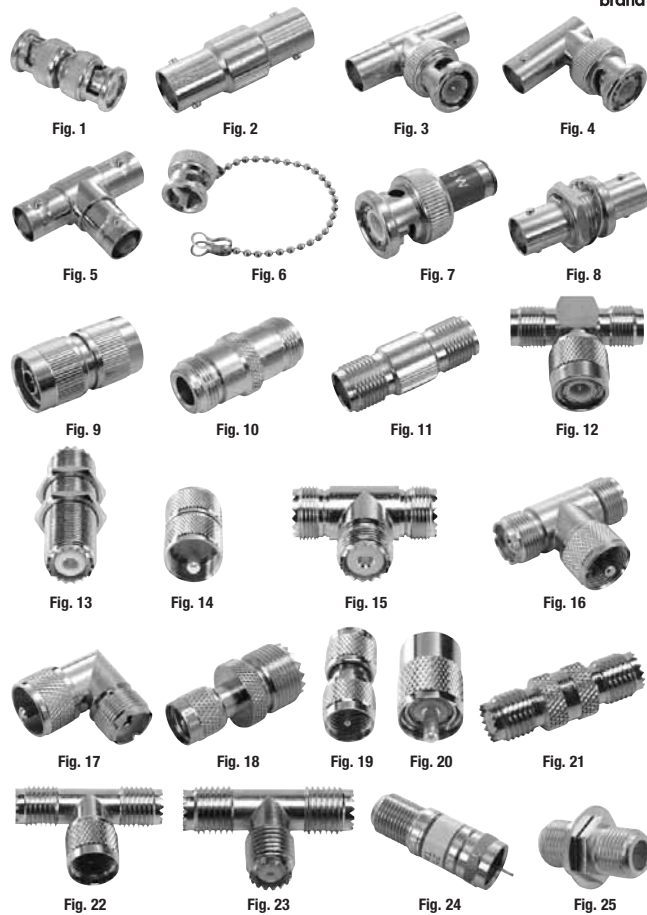

▶ CONTINUED ▶

INTRA-SERIES COAXIAL ADAPTERS

Mfg. Part No.	Fig.	Description	Length	Stock No.	Price Each
● SPC20105	1	BNC Male to BNC Male	2.000"	82K9785	6.71
● SPC15328	1	Economy BNC Male to BNC Male	1.285"	79K4920	3.00
● SPC20106	2	BNC Female to BNC Female	1.250"	82K9786	4.22
● SPC15414	2	Economy BNC Female to BNC Female	1.250"	79K4996	3.94
● SPC4228	3	75-Ohm BNC "T" Connector	1.250"	84N1558	6.27
● SPC15405	3	Economy BNC "T" Female to Male to Female	1.500"	79K4987	3.32
● 1577	4	BNC Female to Right-Angle Male	0.945"	92N3401	8.48
● SPC4231	5	BNC Triple Female	1.276"	84N1561	6.16
● SPC15385	6	Protective Cap for BNC	...	79K4968	3.69
● SPC15280	7	Economy 50-Ohm BNC Terminator	...	79K4877	4.00
● CP-88-T-75	7	75-Ohm BNC Terminator — Purple	...	90N3213	5.57
● SPC15277	7	Economy 75-Ohm BNC Terminator	...	79K4874	4.00
● SPC20104	8	BNC Bulkhead Female to Female (Straight-Thru)	1.281"	82K9784	8.69
● SPC15303	9	N Male to N Male	1.563"	79K4897	9.77
● SPC19904	9	N Male to N Male	1.595"	83K0878	9.23
● SPC19902	10	N Female to N Female	1.750"	83K0876	6.76
● SPC15331	10	N Female to N Female	1.750"	79K4923	8.60
● TNC-JCKJCK SPLICE	11	TNC Female to TNC Female Splice	1.281"	87N816	5.87
● SPC4259	12	TNC Double Female to TNC Male	1.280"	84N1248	12.58
● SPC4269	13	UHF Double Female	1.105"	84N1258	10.93
● SPC4270	14	UHF Double Male	1.315"	84N1259	9.82
● SPC4352	15	UHF Triple Female	1.584"	84N1276	11.32
● SPC15142	16	UHF Female to Male to Female	1.625"	79K4755	9.77
● SPC15227	17	UHF Male to UHF Female, Right-Angle	1.125"	79K4826	8.31
● 1509	18	Mini-UHF Male to UHF Female	1.260"	92N3355	9.91
● SPC4348	19	Mini-UHF Male to Mini-UHF Male	0.990"	84N1272	10.47
● 1511	20	Mini-UHF Male to UHF Male	1.102"	92N3357	6.34
● SPC4271	21	Mini-UHF Female to Mini-UHF Female	1.117"	84N1260	11.14
● SPC4350	22	Mini-UHF Male to Mini-UHF Double Female	1.275"	84N1274	10.38
● SPC4351	23	Mini-UHF Triple Female	1.280"	84N1275	9.97
● 1592	24	F Female to F Male Voltage Blocking Coupler	...	92N3416	5.86
● CPF81-AB	25	CPF 81-AB F Female to F Female	0.875"	32N1114	0.66

▶ CONTINUED ▶

RF COAX – ADAPTERS • RF COAX – APPLICATION TOOLS

INTRA- AND BETWEEN-SERIES COAXIAL ADAPTERS (CONT.)

Mfg. Part No.	Fig.	Description	Length	Price Each	
				Stock No.	1-24
● SPC19901	25	F Female to F Female, 3/4 Inch In-Line Splice	...	83K0875	0.36
● SPC15365	26	F Female Splice	0.938"	79K4951	1.17
● SPC15253	27	SPCF 81-AB F Female to F Female	1.063"	79K4850	1.70
● SPC15465	28	F Female to F Male, Right-Angle	1.125"	79K5039	2.77
● SPC15393	29	F Male to F Male	0.750"	79K4976	2.47
● SPC15167	30	F Triple Female	1.638"	79K4771	2.39
● SPC15147	31	PL-258 Straight Adapter	...	79K4758	3.54
● SPC21081	32	UG-175U/RG/U-58 Reducing Adapter	...	10M8331	0.96
● SPC21082	33	UG-176U/RG/U-59 Reducing Adapter	...	10M8332	0.96

BETWEEN-SERIES COAXIAL ADAPTERS

● SPC20107	34	BNC Male to UHF Female	2.000"	82K9787	5.38
● SPC20108	35	BNC Male to F Female	1.031"	82K9788	6.46
● BNC JACK/UHF PLUG	36	BNC Female to UHF Male	2.000"	81N5463	6.51
● SPC15419	37	50Ω BNC Female to F Male	1.375"	79K5000	3.23
● SPC15264	38	BNC Female to N Female	0.750"	79K4861	8.78
● SPC4217	39	BNC Male to RCA Female	1.102"	84N1547	2.68
● SPC4230	40	BNC 50 Ohm Jack to RCA Plug Between Series Adapter	1.377"	84N1560	3.02
● SPC15334	41	UHF Female to N Male	1.375"	79K4926	8.78
● F-JACK/UHF-PLUG	42	F Female to UHF Male	2.063"	87N823	7.33
● SPC4268	43	N Male to BNC Female	...	84N1257	10.02
● SPC15304	44	N Female to UHF Male	1.406"	79K4898	9.07
● SPC4349	45	Mini-UHF Female to BNC Male	1.217"	84N1273	12.32
● 1510	45	Mini-UHF Male to TNC Female	1.181"	92N3356	10.04
● 1508	46	Mini-UHF Male to N Female	1.181"	92N3354	12.24
● 1593	47	RCA Male to F Female	...	92N3417	2.50
● SPC4263	48	TNC Female to N Female	1.283"	84N1252	12.50
● 1542	49	TNC Female to N Male	1.250"	92N3388	14.78
● 1543	50	TNC Male to N Female	1.300"	92N3389	15.74
● SPC4262	51	TNC Male to UHF Female	1.387"	84N1251	4.82

(8813)

F-TO-BNC BETWEEN-SERIES ADAPTER

- 100% Reliability and Performance
- True 75Ω Design
- Return Loss Attributes
- Industry-Standard Strip Dimensions



Mfg. part no. AD1300 F-to-BNC adapter for upgrading a low-performance F connection to a high-frequency BNC connection. Delivers carrier class performance from cable appliances. Ideal for HDTV set-top boxes, cable modems, direct-to-home satellite receivers, DVD players, VoIP telephone and other consumer appliances where signal degradation can affect performance.

Mfg. Part No.	Description	Stock No.	Price Each	
			1-9	10-24
AD1300	F-to-BNC Between-Series Adapter	06H1718	11.67	
UADRMF220	Right-Angle BNC Male-to-Female Adapter	96B2675	17.03	

(73841)

AMP RF CONNECTOR TERMINATION TOOLS



58433-2

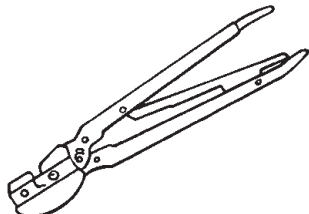

220015-1

PRO-CRIMPER™ II HAND TOOLS

Mfg. Part No.	Description	Stock No.	Price Each
58433-1	PRO CRIMPER™ II Hand Tool Assembly with Die Set for Dual-Crimp BNC/TNC, 58, 62, 59 RG/U. (Die-set interchangeable with other die sets, <i>ordered separately below</i> .)	97F8524	139.84
58433-2	PRO-CRIMPER™ II Hand Tool Assembly with Die Set for Hex-Crimp BNC/TNC, 58, 62, 59 RG/U. (Die-set interchangeable with other die sets, <i>ordered separately below</i> .)	50F1983	139.84
354940-1	PRO-CRIMPER™ II Interchangeable Die Tool Frame (Frame/Handle only, <i>order die sets separately below</i>)	96F6512	54.40

▶ CONTINUED ▶

AMP RF CONNECTOR TERMINATION TOOLS (CONT.)

DIE SETS FOR Mfg. Part No. 354940-1 PRO-CRIMPER™ II TOOL FRAME (ABOVE)

Mfg. Part No.	Description	Stock No.	Price Each
58085-1	Die Set for Dual-Crimp 75-Ohm BNC/TNC, 62, 59 RG/U	89F835	292.50
58425-1	Die Set for Hex-Crimp 75-Ohm BNC, 62, 59, RG/U	97F8525	95.76
58425-2	Die Set for Hex-Crimp 75-Ohm BNC, 179, 161, 187 RG/U	97F8526	95.76
58436-2	Die Set for Hex-Crimp 50-Ohm BNC/TNC, Belden 8281, 9141	97F8528	59.28
58436-3	Die Set for Hex-Crimp 50-Ohm BNC/TNC, 174, 179, 180, 195 RG/U	97F8529	95.76
58489-1	Die Set for Hex-Crimp 50-Ohm SMB	96F7626	175.73

(8341)

ECONOHX™ CRIMP TOOL AND DIES



Econohx™ Crimp Tool

Die

Mfg. Part No.	Description	Stock No.	Price 1-4
227-987	Econohx™ CrimpTool Handle (Without Dies)	90F1652	133.34

DIES FOR ECONOHX™ CRIMP TOOL

Mfg. Part No.	RG/U	Connector Series	Stock No.	Price 1-4
227-1419	55, 58, 59, 62, 140, 141, 142, 142B, 210, 223, 302, 303, 400, Belden 9258, Brand Rex, MG-8X Amphenol 621-6003	Mini-UHF, UHF, BNC, TNC, MHV, SMA	90F1649	124.53
227-1418	122, 161, 174, 179, 180, 187, 188, 195, 316, Amphenol 21-597	BNC, TNC, SMA, Mini-UHF	90F1650	89.41

(8261)

CTL SERIES HEX CRIMP TOOLS



CTL Crimp Tool

Mfg. Part No.	Coaxial Type	Hex Sizes	RG/U	Stock No.	Price 1-4
● CTL-1	BNC, TNC	0.068", 0.213", 0.255"	RG-55, 58, 59, 62, 140, 141, 142, 210, 223, 303, 400, Plenum 59, 62, Belden 9258, 9259, 9907, 89907	93F1552	74.78
● CTL-2	BNC, TNC	0.178", 0.324", 0.068"	RG-6, 174, 179, 187, 188, 316 Plenum 58, Belden 8281	93F1383	74.81
● CTL-3	N	0.100", 0.429", 0.213"	RG-8, 11, 55, 58, 141, 142, 149, 213, 214, 223, 225, 303, 393, 400, Ethernet cables	93F1384	58.80
● CTL-5	BNC, TNC, Mini-UHF, N	0.052", 0.068", 0.100", 0.213", 0.255"	RG-55, 58, 59, 62, 140, 141, 142 210, 223, 303, 400, Plenum 59, 62 Belden 9258, 9259, 9907, 89907	93F7589	74.91
● CTL-6	BNC, TNC	0.052" Sq., 0.178", 0.255", 0.068"	ATT 734A, ATT 735A	93F7590	102.74
CTL-8	BNC, TNC	0.052" Sq., 0.178", 0.255", 0.068"	ATT 734A, ATT 735A	93B0181	278.25
● CTL-9	SMA	0.068", 0.128", 0.178"	RG-180, 316	91F5098	139.19
● CTL-13	Micromate, SMA, SMB	0.105", 0.128", 0.151"	RG-174, 178, 188, 196, 316, RD-316	91F5099	177.33

(8210)